

**MEGAPIX**®  
IP Cameras

DWC-MT94WiAT



Default Login Information	
Username: <b>admin</b>	Password: <b>admin</b>
Default IP Address	
192.168.226.201	

※ The picture might differ according to the specification and model.

※ Contents of this user manual are protected under copyrights and computer program laws.

Rev: 11/20

Before operating the system, please read this User Manual and retain it for future reference.

## Notes on Safety

- This product is intended to be supplied by a Listed Power Unit, marked with 'Limited Power Source', 'LPS' on the unit, output rated minimum 12V/2 A or POE 48V/ 350mA or AC24V (depending on models), no more than 2000m altitude of operation and Tma=60 Deg.C.
- For modes with PoE function, the function of the ITE being investigated to IEC 60950-1 standard is considered not likely to require connection to an Ethernet network with outside plant routing, including campus environment and the ITE is to be connected only to PoE networks without routing to the outside network.
- Do not attempt to disassemble the camera; to prevent electric shock, do not remove screws or covers.
- There are no user-serviceable parts inside. Please contact the nearest service center as soon as possible if there is any failure.
- Avoid incorrect operation, shock vibration, heavy pressing which can cause damage to the product.
- Do not use harsh detergent to clean the camera body. If necessary, please use a soft dry cloth to wipe dirt; for hard contamination, use neutral detergent. Any cleanser for high-grade furniture is applicable.
- Avoid aiming the camera directly towards extremely bright objects such as the sun, as this may damage the image sensor.
- Please follow the instructions to install the camera. Do not reverse the camera, or the reversing image will be received.
- Do not operate it in case temperature, humidity, and power supply are beyond the limited stipulations.
- Keep away from heat sources such as radiators, heat registers, stoves, etc.
- Do not expose the product to the direct airflow from an air conditioner.
- This manual is for using and managing the product. We may reserve the rights of amending the typographical errors, inconsistencies with the latest version, software upgrades and product improvements, interpretation, and modification. These changes will be published in the latest version without special notification.
- All pictures, charts, images in this manual are only for description and explanation of our products. The ownership of trademarks, logos and other intellectual properties related to Microsoft, Apple and Google belong to the above-mentioned companies.

## Disclaimer

- Regarding the product with internet access, the use of the product shall be wholly at your risks. Our company shall be irresponsible for abnormal operation, privacy leakage or other damages resulting from cyber-attack, hacker attack, virus inspection, or other internet security risks; however, Our company will provide timely technical support if necessary.
- Surveillance laws vary from country to country. Check all laws in your local region before using this product for surveillance purposes. We shall not take the responsibility for any consequences resulting from illegal operations.

## Regulatory Information

### FCC Marking



The products have been tested and found in compliance with the council FCC rules and regulations part 15 subpart B. Operation of this product is subject to the following two conditions: (1) this device may not cause harmful interference, and (2) this device must accept any interference received, including interference that may cause undesired operation.

**RoHS** The products are designed and manufactured according to Directive EU RoHS Directive 2011/65/EU and its amendment Directive EU 2015/863 on the restriction of the use of certain hazardous substances in electrical and electronic equipment.

# Table of Contents

<b>1</b>	<b>Introduction</b> .....	<b>5</b>
1.1	Product and Accessories.....	5
1.2	Part Name.....	6
<b>2</b>	<b>Installation</b> .....	<b>7</b>
2.1	Installing the camera .....	7
2.2	Cabling .....	8
2.3	Inserting/Removing the SD Card .....	9
<b>3</b>	<b>Live View</b> .....	<b>10</b>
<b>4</b>	<b>Camera Configuration</b> .....	<b>11</b>
4.1	System Configuration.....	11
4.1.1	Basic Information .....	11
4.1.2	Date and Time.....	11
4.1.3	Local Config.....	12
4.1.4	Storage.....	13
4.2	Image Configuration .....	14
4.2.1	Display Configuration .....	14
4.2.2	Video / Audio Configuration.....	16
4.2.3	OSD Configuration .....	17
4.2.4	Video Mask .....	18
4.2.5	ROI Configuration.....	19
4.2.6	Lens Control.....	19
4.3	Alarm Configuration.....	20
4.3.1	Motion Detection.....	20
4.3.2	Other Alarms .....	21
4.3.3	Alarm In .....	22
4.3.4	Alarm Out.....	23
4.3.5	Alarm Server .....	24
4.4	Event Configuration .....	25
4.4.1	Video Tampering Detection .....	25
4.4.2	Line Crossing .....	26
4.4.3	Perimeter Intrusion.....	28
4.5	Network Configuration .....	30
4.5.1	TCP/IP.....	30
4.5.2	Port .....	31
4.5.3	DDNS .....	31
4.5.4	SNMP.....	32
4.5.5	802.1x .....	32
4.5.6	RTSP.....	33
4.5.7	UPnP.....	34
4.5.8	E-mail.....	34
4.5.9	FTP.....	35
4.5.10	HTTPS.....	35
4.5.11	QoS .....	35
4.6	Security Configuration.....	36
4.6.1	User Configuration .....	36
4.6.2	Online User .....	37
4.6.3	Block and Allow Lists.....	37
4.6.4	Security Management.....	38
4.7	Maintenance Configuration .....	39
4.7.1	Backup and Restore .....	39
4.7.2	Reboot.....	39







4.7.3	Upgrade.....	39
4.7.4	Operation Log.....	39
<b>5</b>	<b>Search .....</b>	<b>40</b>
5.1	Image Search.....	40
5.1.1	Local Image Search.....	40
5.1.2	SD Card Image Search .....	41
5.2	Video Search.....	41
5.2.1	Local Video Search.....	42
5.2.2	SD Card Video Search .....	42
5.2.3	Video clip and downloading.....	43
<b>6</b>	<b>Appendix .....</b>	<b>44</b>
6.1	Troubleshooting .....	44
6.2	Dimensions.....	45
	DWC-MT94WiAT .....	45
6.3	Specifications.....	46
<b>7</b>	<b>Warranty Information .....</b>	<b>48</b>
<b>8</b>	<b>Limits and Exclusions .....</b>	<b>49</b>

# 1 Introduction

## 1.1 Product and Accessories

Please make sure the camera and accessories listed below are included in the package:



WHAT'S IN THE BOX					
Quick setup and Installation guides		1 set	Tapping Screws - 3pcs		1 set
Mounting Template		1	Plastic Plugs - 3pcs		1 set
Waterproof Cap		1 set	Rubber Plug		1
Hexagonal Wrench		1			

## 1.2 Part Name

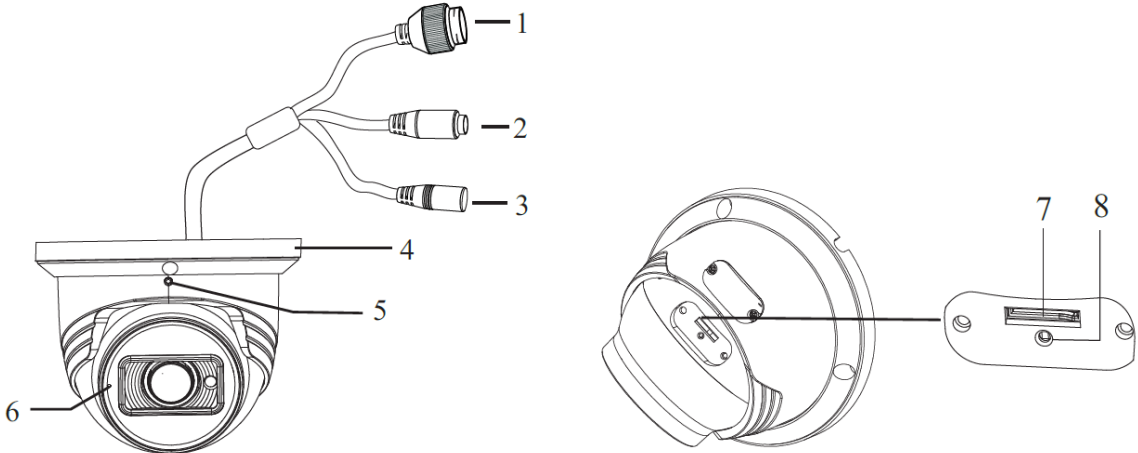

No.	Description
1	RJ45 Internet Connector
2	Audio Input Connector
3	Power Connector
4	Mounting Base
5	Fixed Screw
6	Microphone
7	Micro SD Card Slot
8	Reset Button

## 2 Installation

### 2.1 Installing the camera

1. The mounting surface must bear five times the weight of your camera.
2. Do not let the cables get caught in improper places or the electric line cover to be damaged. This may cause a breakdown or fire.
3. Using the mounting template sheet or the camera itself, mark and drill the necessary holes in the wall or ceiling.

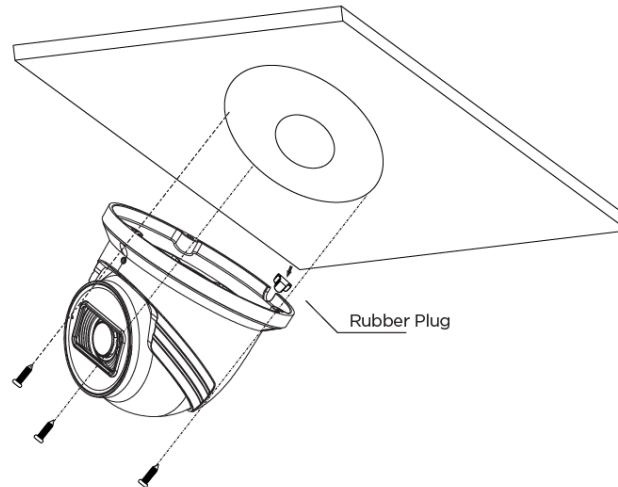

4. Pass wires through and make all connections. See “Cabling” for more information.
5. Mount the camera to the mounting surface using the included screws and anchors.
6. To use the camera’s waterproof wiring:
  - a. Install the LAN cable into ‘a’.
  - b. ‘b’ will be assembled to ‘a’ with a 1/4 turn.
  - c. Thread ‘c’ tightly to ‘b’.

**NOTE:** To ensure moisture seal, make sure the o-ring is in place between (a) and (b). In extreme environments use of an outdoor rated sealer is recommended.

**NOTE:** When using the waterproof cap, crimp the RJ45 connector after passing the cable through the waterproof cap.

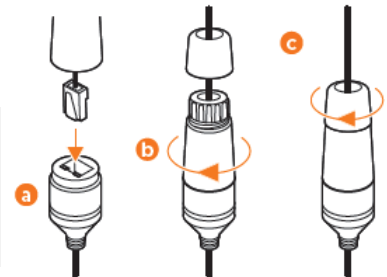

7. Once all cables are connected to the camera, secure the camera to the mounting surface using the three (3) included screws.

**Resetting the camera:** To reset the camera, use the tip of a paper clip or a pencil and press the reset button. Loosen the lock screw under the camera’s lens and rotate the camera module to access the control panel. Open the control panel cover on the top of the camera module to access the control panel. Pressing the button for five (5) seconds will initiate a camera-wide reset of all the settings, including network settings.

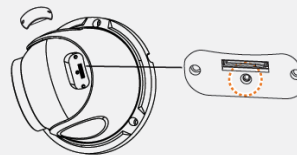

8. Adjusting the camera’s angle by loosening the lock screw at the base of the camera. When the adjustment is complete, make sure the fixed screw is secured tightly in place.

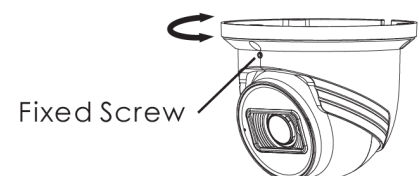

## 2.2 Cabling

Use a PoE-enabled switch to connect data and power through a single cable and begin viewing and recording images instantly.

A non-PoE switch will require an adaptor for power transmission.

1. NETWORK CONNECTIONS - Using a PoE Switch or PoE Injector, connect the camera using an Ethernet cable for both data and power.
2. NETWORK CONNECTIONS - Not using PoE Switch or PoE Injector, connect the camera to the switch using an Ethernet cable for data transmission and use a power adaptor to power the camera.

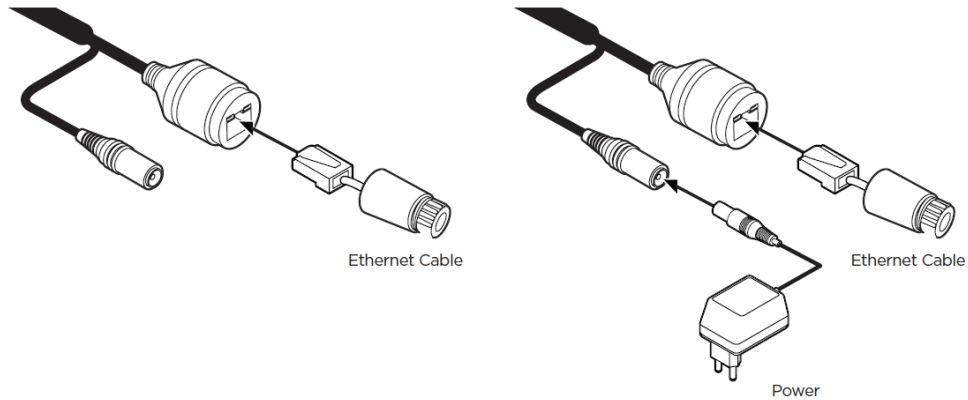

Use the diagram below to connect all supported external devices to the camera.

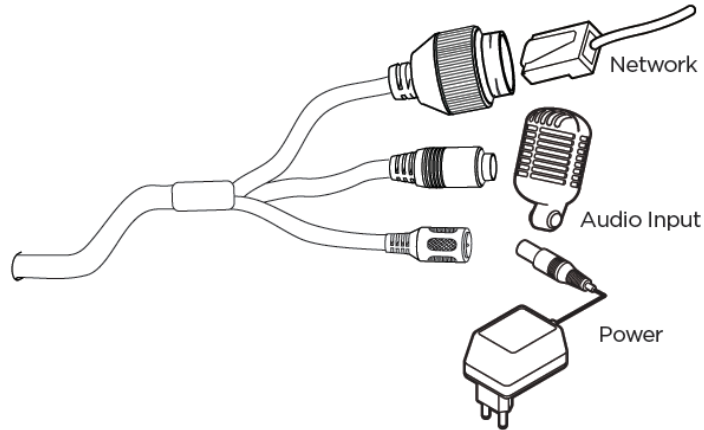

No.	Description
Network Cable	Connect a crossover cable into the RJ-45 port.
Audio Input	Connect the 'audio in' port of the camera to the microphone directly or 'line out' port of the amplifier connected with a microphone. If the microphone is connected directly, the microphone with the embedded amplifier such as condenser mic. needs to be used.
Power Input	Please, check the voltage and current capacity of the rated power carefully. Power requirements: DC12V, PoE (IEEE 802.3af class 3). Adapter not Included. Power consumption: <9.5W



---

## 2.3 Inserting/Removing the SD Card

1. To install the camera's SD Card, locate the SD card slot at the base of the camera module by removing the cover dome.
2. Insert class 10 SD/SDHC/SDXC card into the SD card slot by pressing the SD card until clicks.
3. To remove the SD card, press the card inward until it clicks to release from the card slot then pull out from the slot.

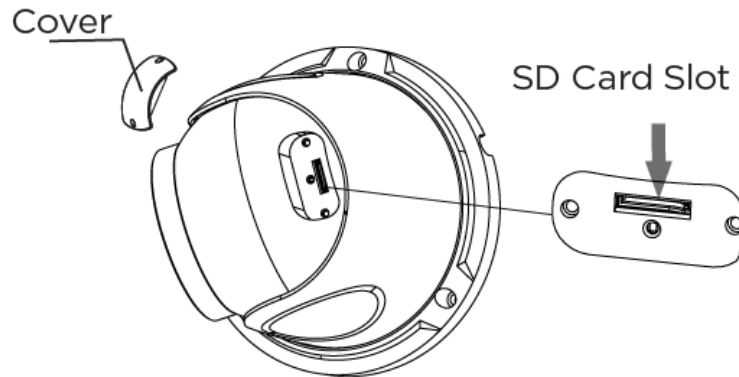

### 3 Live View

1. Open an Internet Explorer (IE) web browser.
2. Enter the camera's IP address in the address bar. Enter the camera's username and password (default username and password are admin | admin).
3. You may be prompted to install the NetAIIPC camera plug-in to view video from the camera. Click on the link above the login to download and install the plug-in.
4. When logging into the camera for the first time, you will be prompted to change the default admin password. It is highly recommended that you change the camera's default password.
5. After logging into the camera's web viewer, the following window will be shown. The camera's view includes four (4) tabs on the top right, that allow users to navigate between the live view, configuration menu, search video and log out.

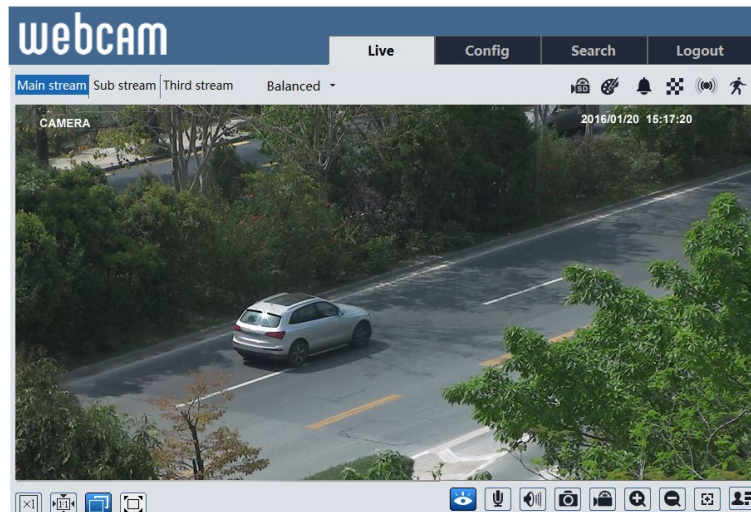

Icon	Description	Icon	Description	Icon	Description
	Original size		Sensor alarm indicator*		Start/stop local recording
	Fit correct scale		Motion alarm indicator		Zoom in
	Auto (fill the window)		Color abnormal indicator		Zoom out
	Fullscreen		Abnormal clarity indicator		Auto Zoom control*
	Start/stop live view		Scene change indicator		Zoom +/-
	Start/stop two-way audio*		Line crossing indicator		Focus +/-
	Enable/disable audio*		Intrusion indicator		SD card recording indicator*
	Snapshot				

\* NOTE: Functions above may be disabled based on the camera model.

In fullscreen mode, double-click anywhere on the screen or press the ESC key on the keyboard to exit the fullscreen.

## 4 Camera Configuration

To access the camera's settings and configuration, click on the 'Config.' tab on the top right side of the camera's main view. The following setting options will be available:

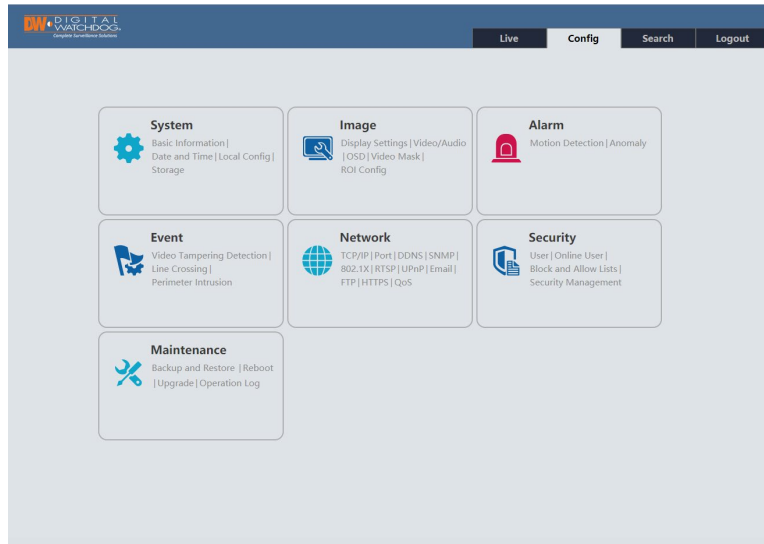

### 4.1 System Configuration

#### 4.1.1 Basic Information

This option shows the camera's basic network information. Users can adjust the device's name, view the current settings version and MAC address.

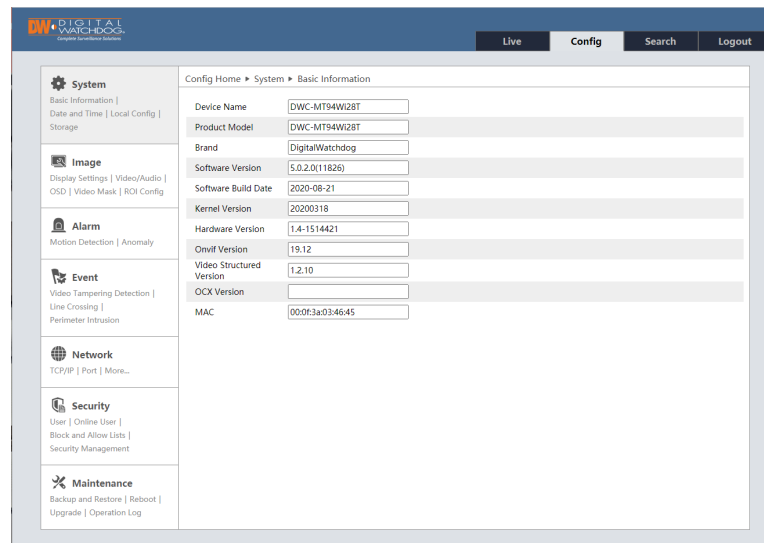

#### 4.1.2 Date and Time

Open this setup page to configure the camera's date, time, and time zones as needed.

It is always recommended to setup the camera's date and time when you access the camera for the first time to avoid issues with recording or events.

Choose the correct time zone from the drop-down menu options.

If needed, enable the daylight savings time (DST). You can set the DST settings to apply automatically, or manually enter the start and end time for the DST period.

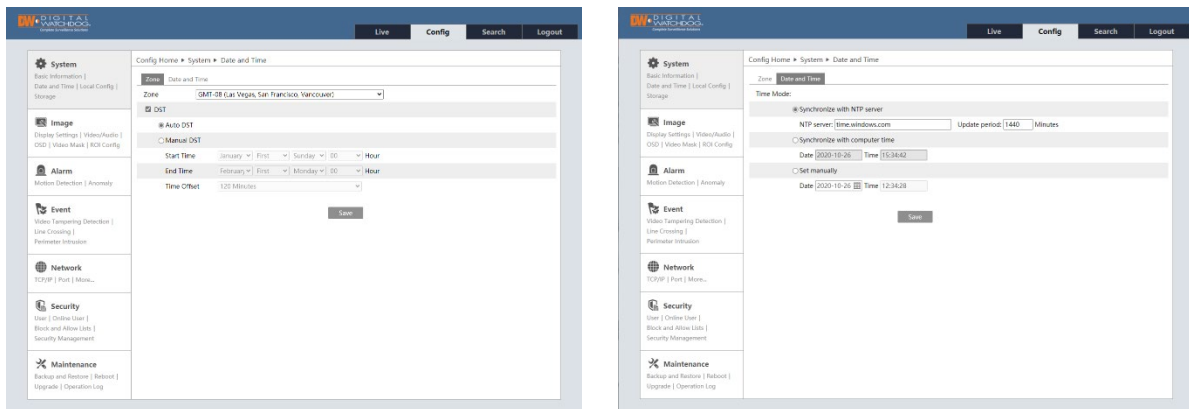

When setting up the camera's time, users can select to synchronize the camera with an NTP server. If enabled, enter the server's address and how often the time synchronization will take place. You can also set the camera to synchronize with a local computer or enter the time for the camera manually.

#### 4.1.3 Local Config.

For screen captures and event images, a path must be set in the local directory where images will be saved. Use this configuration screen to select the directory path for captured pictures and recorded videos on the local PC. Users can also enable or disable the bitrate display in the recorded files.

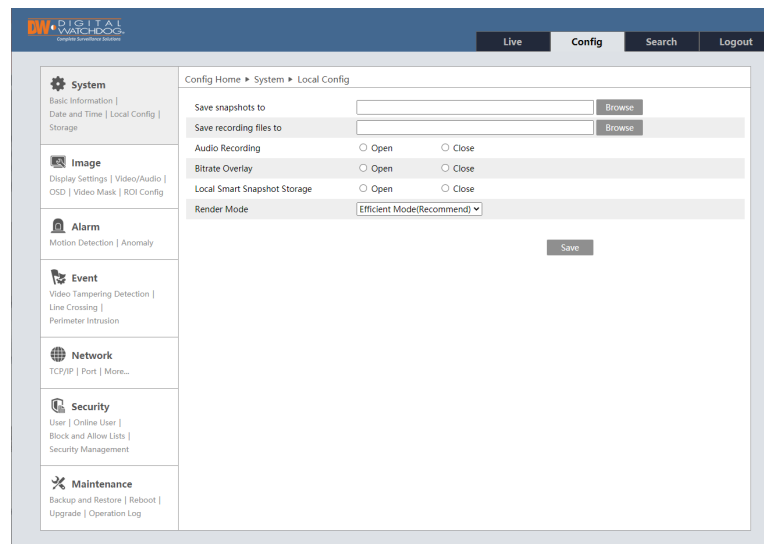

“Local smart snapshot storage” assigns captured pictures triggered by smart events (line crossing, intrusion, etc.) to be saved to the local PC.

#### 4.1.4 Storage

The Storage Configuration screen lets users manage the SD card (not included) and setup recording settings.

Management Record Snapshot

Total picture capacity	14829 MB
Picture remaining space	5068 MB
Total recording capacity	14784 MB
Record remaining space	0 MB
State	Normal
Snapshot Quota	50 %
Video Quota	50 %

Changes in the quota ratio need to be formatted before they become effective.

Eject Format

Management Record Snapshot

**Record Parameters**

Record Stream: Main

Pre Record Time: No Pre Record (H264,H265,MJPEG)

Cycle Write: Yes

**Timing**

Enable Schedule Record

- SD Card Management

Users can check the total SD card capacity and remaining storage for both pictures and video recordings. Click the “Format” button to format the SD card. All data will be cleared by clicking this button. Click the “Eject” button to stop writing data to the SD card. Then the SD card can be ejected safely.

**Snapshot Quota:** Set the capacity proportion of captured pictures on the SD card.

**Video Quota:** Set the capacity proportion of record files on the SD card.

- Schedule Recording Settings

Users can select the stream to record, add pre-recording time, and select whether to override old data when the SD card is full. Users can also setup a recording schedule for the camera by checking the box under ‘Timing’. The schedule below will appear.

Select which hours, from 0 to 24, for each day, will have SD card recording enabled. Green means scheduled. Blank means unscheduled.

“Add”: Add the schedule for a special day. Drag the mouse to set the time on the timeline.

“Erase”: Delete the schedule. Drag the mouse to erase the time on the timeline.

Manual Input: Click it for a specific day to enter specific start and end times. This adds more granularities (minutes).

Users can also add “Holiday Schedule” to be applied to special dates.

Note: The holiday schedule takes priority over the weekly schedule.

Week Schedule

Sun. 00:00-24:00 Manual Input

Mon. 00:00-24:00 Manual Input

Tue. 00:00-24:00 Manual Input

Wed. 00:00-24:00 Manual Input

Thu. 00:00-24:00 Manual Input

Fri. 00:00-24:00 Manual Input

Sat. 00:00-24:00 Manual Input

Holiday Schedule

Date: 07-12 Add Delete

- Snapshot Settings

For still images captured for events, set the format, resolution and quality of the image. Users can also set the interval and quantity of snapshots captured by each event triggered.

**Snapshot Quantity:** The maximum number of snapshots captured per event. The actual number of snapshots may be less.

**Timing Snapshot:** If enabled, users can setup a schedule when snapshots are enabled. Users must set the snapshot interval for the schedule separately and set the schedule the same way the Recording Schedule works.

Management Record Snapshot

**Snapshot Parameters**

Image Format: JPEG

Resolution: 704x576

Image Quality: Low

**Event Trigger**

Snapshot Interval: 1 Second

Snapshot Quantity: 5

**Timing**

Enable Timing Snapshot

Snapshot Interval: 5 Second

## 4.2 Image Configuration

The Image Configuration menu includes Display, Video/Audio, OSD, Video Mask and ROI Configuration.

### 4.2.1 Display Configuration

The image's settings can be adjusted from this screen. The setting screen includes a small preview of the camera's view to see the applied settings for a more accurate setup.

Users can also set different profiles for day and night modes.

Settings are applied and saved automatically unless indicated otherwise.

The screenshot displays the 'Display Settings' configuration page for a camera. The interface is divided into a left sidebar and a main content area. The sidebar contains navigation menus for System, Image, Alarm, Event, Network, Security, and Maintenance. The main content area features a breadcrumb trail 'Config Home > Image > Display Settings' and two tabs: 'Camera Parameters' (selected) and 'Schedule'. A small camera preview window shows a person walking in a hallway. To the right of the preview is a list of settings, each with a control element (slider, checkbox, or dropdown) and a numerical value. The settings include Brightness (25), Contrast (50), Hue (50), Saturation (50), Sharpness (50), Noise Reduction (30), Defog (50), Lens Distortion Correction (80), BLC (Off), HFR (Off), Antiflicker (Off), Smart IR (Off), White Balance (Auto), Frequency (60HZ), Day/Night Mode (Auto), Sensitivity (Mid), Delay Time (2), Infra-red Mode (Auto), Exposure Mode (Auto), Gain Mode (Auto), Gain Limit (50), Corridor Pattern (0), Image Mirror (Close), and Image Flip (Close). At the bottom of the settings list are 'Default' and 'Revoke' buttons.

- **Brightness:** The higher the number, the brighter the image will be. The default value is 25.
- **Contrast:** The higher the number, the more contrast between colors will appear in the image. The default value is 50.
- **Hue:** Set the total color degree of the image. The default value is 50.
- **Saturation:** Set the degree of color purity. The purer the color, the brighter the image is. The default is 50.
- **Sharpness:** Check the box to enable. The higher the number, the sharper lines in the image will appear. The default is 50.
- **Noise Reduction:** Check the box to enable. Reduce the digital noise in the camera. The higher the value, the more noise will be removed from the image, but it will also reduce the image resolution. The default is 30.
- **Defog:** Check the box to enable. When enabled, the camera will compensate and improve the image in case of a foggy, dusty, smoggy, or rainy environment to get clear images. The default value is 50.
- **Lens Distortion Correction:** Check the box to enable. When the image appears distorted this feature is used to correct that. The default value is 80 (Available only on supporting models).
- **Backlight Compensation (BLC):** Select from the following drop-down options:

- Off: disable backlight compensation. Default mode.
  - HWDR: True WDR adjusts the camera to provide a better image when there are both very bright and very dark areas in the field of view. If enabled, the camera recording will be stopped for a few seconds while HWDR is turning on.
  - HLC: This option lowers the brightness of the entire image by suppressing the image's bright area and reducing the size of the halo area.
  - BLC: When enabled, the auto exposure will activate according to the scene so that objects in the darkest area will be seen clearly.
- **HFR:** High Frame Rate. If enabled, the system will restart with the mainstream's maximum frame rate can be set to 60fps.
- **Anti-flicker:**
  - Off: disable the anti-flicker function. This is used mostly in outdoor installations (default).
  - 50Hz: reduce flicker in 50Hz lighting conditions.
  - 60Hz: reduce flicker in 60Hz lighting conditions.
- **Smart IR:** This function avoids image overexposure and underexposure by controlling the brightness of the IR lights according to the environmental conditions. This feature is disabled by default.
- **White Balance:** Adjust the color temperature according to the environment.
  - **Auto:** Adjust the color temperatures automatically based on the current environment (default).
  - **Indoor:** Adjust the color temperature for indoor installations.
  - **Outdoor:** Set the color temperature for outdoor installations.
  - **Manual:** Set the color temperature manually. If selected, adjust the Red Gain and Blue Gain values as needed.
- **Frequency:** 50Hz and 60Hz can be optional (Default value is 60Hz).
- **Day/Night Mode:**
  - **Auto:** The camera will switch between color and B/W modes automatically based on the lighting conditions (default). Adjust the light sensitivity from the drop-down option (Mild is the default value). If needed, users can add a delay, in seconds, before the camera switches between color and B/W.
  - **Day:** The camera will remain in color mode regardless of the lighting conditions.
  - **Night:** The camera will remain in B/W mode regardless of the lighting conditions.
  - **Timing:** If selected, set the hours when the camera will switch to color (daytime) and B/W (night-time).
- **Infra-red Mode:** Choose "Auto", "ON" or "OFF".
- **Exposure Mode:**
  - Auto: The camera's exposure is adjusted automatically based on the lighting conditions (default).
  - Manual: Manually adjust the digital shutter speed.
- **Gain Mode and limit:** Select from auto (default) and manual. If the gain mode is set to auto, adjust the gain limit (default is 50). If "Manual" is selected, adjust the gain value (50 is the default).
- **Corridor Pattern:** Corridor modes are for situations such as long hallways, where the camera is mounted at a sharp angle to capture the entire scene. 0°, 90°, 180° and 270° options are available. The default value is 0. The video resolution should be 2.1MP/1080p or lower if this function is used.
- **Image Mirror:** Turn the current image horizontally.
- **Image Flip:** Turn the current image vertically.

Users can setup a schedule for the different profiles to go into effect. To enable, click on the "Schedule" tab on the top left and select "Timing" from the Schedule drop-down options.

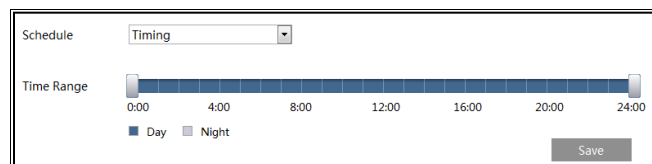
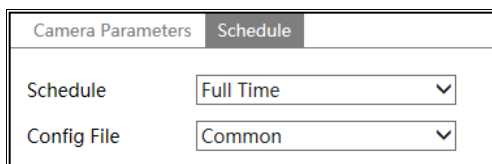

Drag the time bar icons to set the time of day and night. Blue means day time and blank means night time.

If the current mode of camera parameters is set to schedule, the image configuration mode will automatically switch between day and night according to the schedule.

#### 4.2.2 Video / Audio Configuration

Set the resolution, frame rate, bitrate type, and video quality and so on subject to the actual network condition.

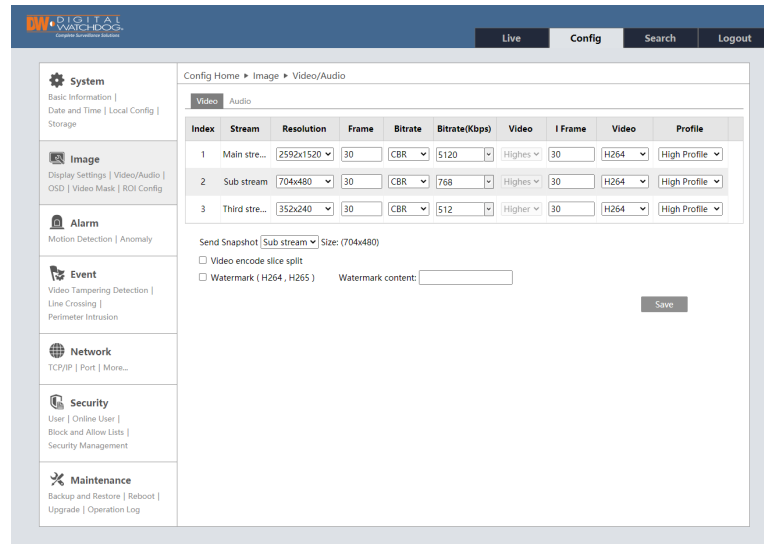

Three video streams can be adjustable.

- **Resolution:** Select the resolution for each stream from the drop-down options.
- **Frame rate:** The higher the frame rate, the video is smoother. The maximum value is 30 unless HFR is enabled under Display Settings.
- **Bitrate type:** Select from CBR and VBR. If CBR is selected, no matter how much change is seen in the video scene, the compression bitrate will remain constant. If VBR is selected, the compression bitrate will vary according to scene changes. This can help optimize network bandwidth usage.
- **Bitrate:** When the bitrate mode is set to CBR, adjust the bitrate in Kbps. The higher the bitrate, the better the image quality will be.
- **Video Quality:** When bitrate type is set to VBR, adjust the video quality from the drop-down options. The higher the image quality, the more bitrate will be required.
- **I-Frame interval:** Determine how many frames are allowed between a “group of pictures”. If there is not much movement in the scene, setting the I-Frame value higher than the frame rate can result in less bandwidth usage. If the I-Frame value is set too high, and there are frequent changes in the scene, there is a risk of frame skipping.
- **Video Compression:** Select the compression for each stream from H.265, H.264, or MJPEG (MJPEG is not available for the mainstream). When selecting H.265, make sure the client system supports this codec. Compared to H.264, H.265 reduces the transmission bitrate under the same resolution, frame rate and image quality.
- **Profile:** When selecting H.264 as the compression, select the applicable profile. Baseline, main and high profiles are selectable.
- **Send Snapshot:** Select which stream will capture snapshots when events occur.
- **Video encode slice split:** When enabled, the camera will stream a smooth image through a low-performance PC.
- **Watermark:** If enabled a watermark will be added to the recorded video. The watermark text can be entered by the user as needed.



For cameras with audio input, microphone built-in, or audio output, click the “Audio” tab to go to the interface as shown below.

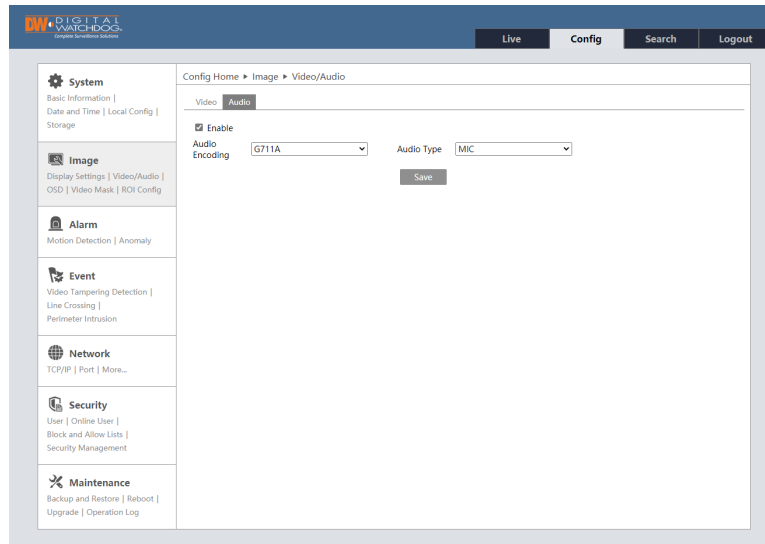

- **Audio Encoding:** Select the audio encoding from the drop-down menu. G711A and G711U are selectable.
- **Audio Type:** If the camera has a built-in microphone, select to enable audio input from the microphone or external audio input (LIN).

### 4.2.3 OSD Configuration

The OSD settings page allows users to set up a text overlay on the video, showing the date and time, device name, etc.

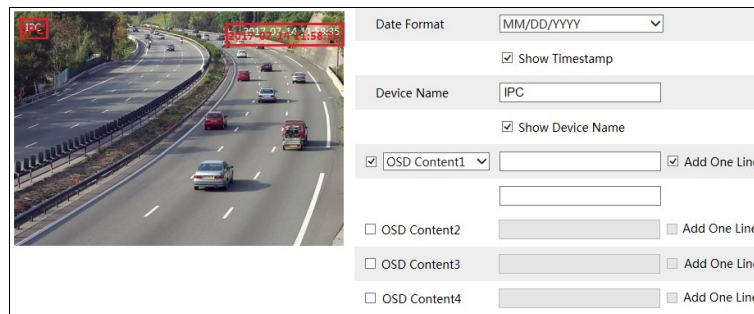

To set a timestamp, device name, or OSD content and picture overlap, check the box next to each field. For the time stamp, select the date and time format you wish to use. For all other settings, enter the text that will appear over the camera’s video. Once enabled, users can click-and-drag the text frames to the desired position on the camera’s preview screen. Click the “Save” button to save the settings.

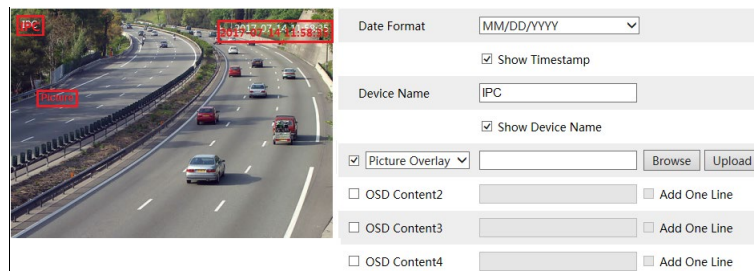

---

Picture Overlay Settings:

The cameras support a picture overlay option. When selected, click “Browse” to select the overlapping picture. Then click “Upload” to upload the picture. The overlapping image should not exceed 200x200 pixels, or the upload will fail.

#### 4.2.4 Video Mask

To set up privacy masks in the camera’s view, check the enable button on this menu page. The camera supports up to 4 separate zones.

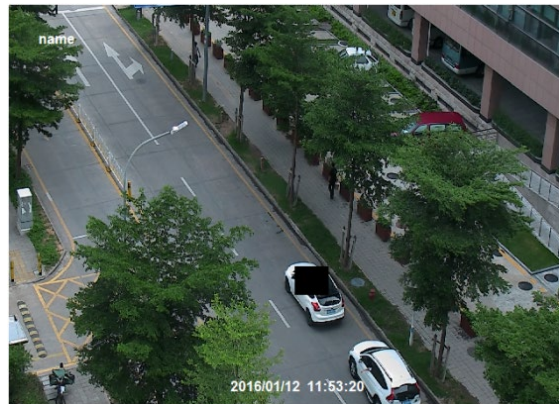
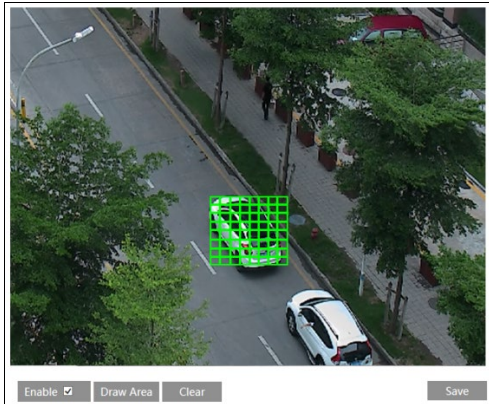

To set up a video privacy mask:

1. Check the box next to “Enable”.
2. Click the “Draw Area” button. Use the mouse cursor to drag and draw the mask area on the camera's preview.
3. Click the “Save” button to save the settings.
4. Return to the live to verify that the area has been drawn as shown as blocked out in the image.

To clear the video mask:

Click the “Clear” button to delete the current mask area.

#### 4.2.5 ROI Configuration

An area in the image can be set as a region of interest. This area will have a higher bitrate than the rest of the image, resulting in better image quality for the identified area.

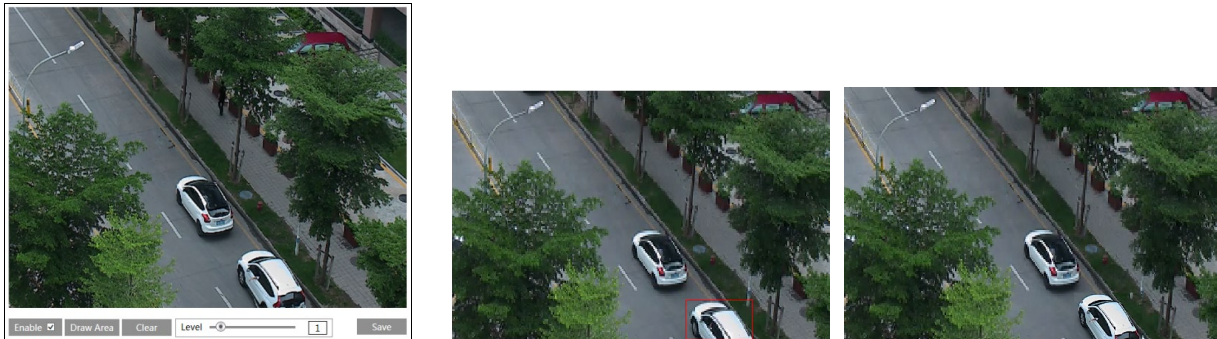

1. Check the box next to “Enable”.
2. Click the “Draw Area” button. Use the mouse cursor to drag and draw the ROI area on the camera’s preview.
3. Set the quality level. The higher the number, the higher the video quality in the ROI will be.
4. Click the “Save” button to save the settings.
5. Return to the live to verify that the area has been drawn as shown as blocked out in the image.

#### 4.2.6 Lens Control

**This function is available for models with a motorized zoom lens (DWC-MT94WiAT and DWC-MV94WiAT).** Use this setup screen to adjust the camera’s zoom and focus.

Users can manually adjust the camera’s zoom and focus from the live view, or this preview settings page. Users can also select to switch the focus when the camera switches between color and B/W.

If the camera still appears to be out of focus, use the “One Key Focus” to adjust the focus automatically based on the camera’s current view.

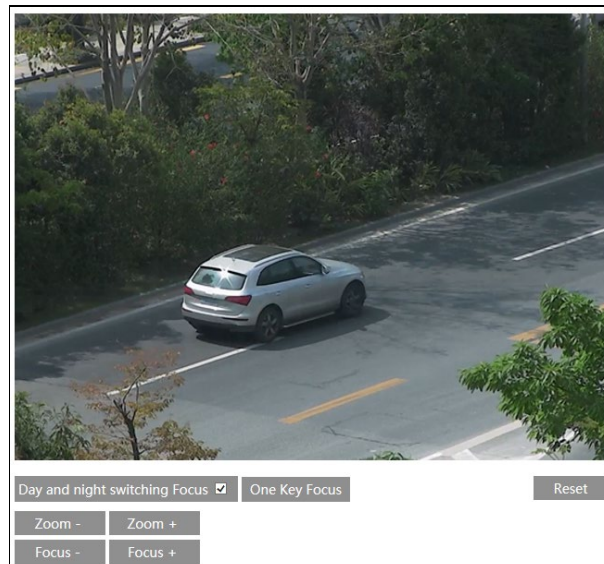

## 4.3 Alarm Configuration

### 4.3.1 Motion Detection

This setup menu allows users to set the camera's motion detection alarm.

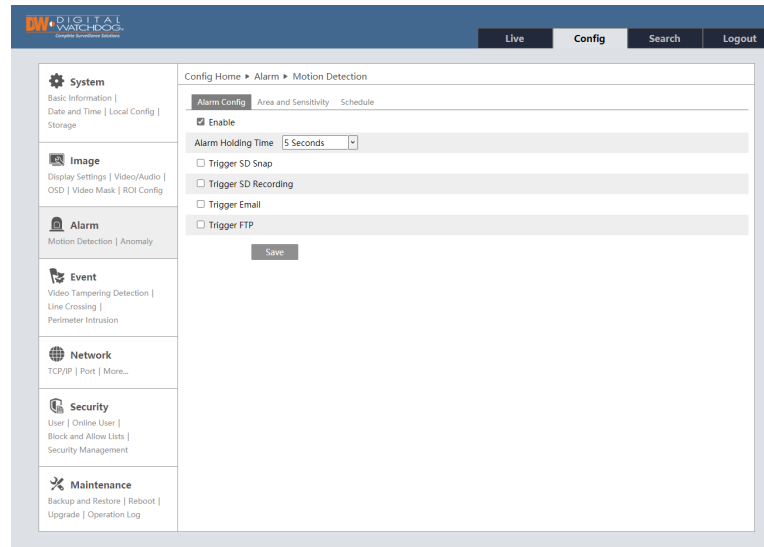

1. Check the “Enable” box. If unchecked, the camera will not send out any motion-based triggers, even if there is motion in the video.
  - **Alarm Holding Time:** Set the time between each event notification.
  - **Trigger Alarm Out:** For cameras with an alarm output connection, check the box for the camera to trigger the alarm output.
  - **Trigger SD Snap:** Check the box to send a screenshot to the SD card when motion is detected.
  - **Trigger SD Recording:** Check the box to send a video recording to the SD card when motion is detected.
  - **Trigger E-mail:** Check the box to set out an e-mail notification when motion is detected. Enter the e-mail addresses to receive the notification. To send the e-mail to more than one e-mail address, separate the accounts with a comma. Check the box next to “Attach Picture” to include a screenshot of the event. Enter the e-mail subject and any notes, in the content field. The sending e-mail address must be set in the E-mail configuration interface before e-mail notifications can work.
  - **Trigger FTP:** Check the box to send a screenshot of the event to an FTP server. Enter the server's address in the field. See the FTP configuration section for more information.
2. Click on the “Area of Sensitivity” tab and set the motion detection area and sensitivity.

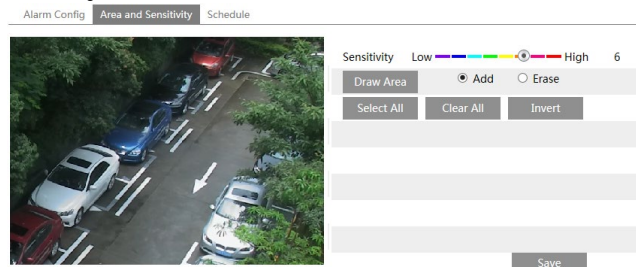

- Move the “Sensitivity” scroll bar to set the sensitivity. The higher the sensitivity value, the motion detection will be triggered based on smaller changes in the scene.
- Select “Add” and click “Draw Area”. Drag the mouse to draw the motion detection area on the camera's preview. Select “Stop Draw” when you are done. Check the “Erase” box and drag the mouse to clear the motion detection area.
- Click “Save” to save the settings.

3. Click on the “Schedule” tab to set the motion detection schedule. Select which hours, from 0 to 24, for each day, will have SD card recording enabled. Green means scheduled. Blank means unscheduled.

- “Add”: Add the schedule for a special day. Drag the mouse to set the time on the timeline.
- “Erase”: Delete the schedule. Drag the mouse to erase the time on the timeline.
- Manual Input: Click it for a specific day to enter specific start and end times. This adds more granularities (minutes).
- Users can also add “Holiday Schedule” to be applied to special dates.  
Note: The holiday schedule takes priority over the weekly schedule.

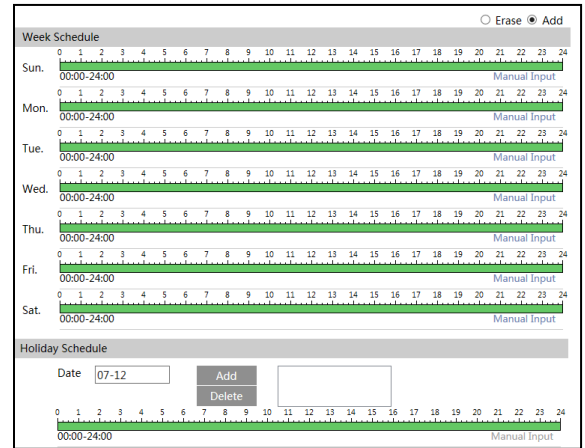

### 4.3.2 Other Alarms

#### SD Card Full

Use this setup to send out notifications when the SD card is full. Check the “Enable” box.

- **Alarm Holding Time:** Set the time between each event notification.
- **Trigger Alarm Out:** For cameras with an alarm output connection, check the box for the camera to trigger the alarm output.
- **Trigger E-mail:** Check the box to set out an e-mail notification when motion is detected. Enter the e-mail addresses to receive the notification. To send the e-mail to more than one e-mail address, separate the accounts with a comma. Check the box next to “Attach Picture” to include a screenshot of the event. Enter the e-mail subject and any notes, if needed, in the content field. The sending e-mail address must be set in the E-mail configuration interface before e-mail notifications can work.
- **Trigger FTP:** Check the box to send a screenshot of the event to an FTP server. Enter the server’s address in the field. See the FTP configuration section for more information.

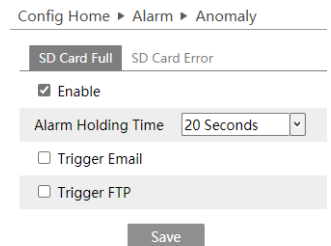

#### SD Card Error

Use this setup to send out notifications when the SD card is full. Check the “Enable” box.

- **Alarm Holding Time:** Set the time between each event notification.
- **Trigger Alarm Out:** For cameras with an alarm output connection, check the box for the camera to trigger the alarm output.
- **Trigger E-mail:** Check the box to set out an e-mail notification when motion is detected. Enter the e-mail addresses to receive the notification. To send the e-mail to more than one e-mail address, separate the accounts with a comma. Check the box next to “Attach Picture” to include a screenshot of the event. Enter the e-mail subject and any notes, if needed, in the content field. The sending e-mail address must be set in the E-mail configuration interface before e-mail notifications can work.
- **Trigger FTP:** Check the box to send a screenshot of the event to an FTP server. Enter the server’s address in the field. See the FTP configuration section for more information.

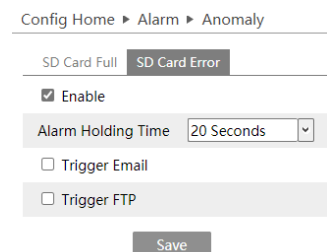

## IP Address Conflict

This function is available on models with the Alarm Out interface.

The screenshot shows the configuration page for 'IP Address Collision'. At the top, there are tabs for 'SD Card Full', 'SD Card Error', 'IP Address Collision', and 'Cable Disconnected'. The 'IP Address Collision' tab is selected. Below the tabs, there is an 'Enable' checkbox which is checked. Underneath, there is a field for 'Alarm Holding Time' set to '20 Seconds'. Below that is a section titled 'Trigger Alarm Out' with a checkbox for 'Alarm Out' which is checked.

Click “Enable alarm” and set the alarm holding time.

When the IP address of the camera conflicts with the IP address of another device on the network, the system will trigger the alarm out selected under “Trigger Alarm Out”.

## Cable Disconnection

This function is available on models with the Alarm Out interface.

The screenshot shows the configuration page for 'Cable Disconnected'. At the top, there are tabs for 'SD Card Full', 'SD Card Error', 'IP Address Collision', and 'Cable Disconnected'. The 'Cable Disconnected' tab is selected. Below the tabs, there is an 'Enable' checkbox which is checked. Underneath, there is a field for 'Alarm Holding Time' set to '20 Seconds'. Below that is a section titled 'Trigger Alarm Out' with a checkbox for 'Alarm Out' which is checked.

Click “Enable” and set the alarm holding time.

When the camera gets disconnected, the system will trigger the alarm out selected under “Trigger Alarm Out”.

### 4.3.3 Alarm In

The alarm input menu is available on models with alarm input and output support (DWC-MV94Wi28T, DWC-MV94Wi36T and DWC-MV94WiAT). To set sensor alarm (alarm in):

The screenshot shows the configuration page for 'Alarm In'. At the top, there are tabs for 'Alarm Config' and 'Schedule'. The 'Alarm Config' tab is selected. Below the tabs, there is an 'Enable' checkbox which is checked. Underneath, there is a field for 'Alarm Type' set to 'NO'. Below that is a field for 'Alarm Holding Time' set to '20 Seconds'. Below that is a field for 'Sensor Name'. Below that is a section titled 'Trigger Alarm Out' with a checkbox for 'Alarm Out' which is checked. Below that are four checkboxes: 'Trigger Snap', 'Trigger SD Recording', 'Trigger Email', and 'Trigger FTP', all of which are unchecked.

1. Click “Enable”
  - Set the alarm type (NO/NC)
  - Set the alarm holding time (dwell time between each alarm trigger)
  - Enter the sensor name.
2. Set alarm trigger options.
  - **Trigger Alarm Out:** For cameras with an alarm output connection, check the box for the camera to trigger the alarm output.
  - **Trigger SD Snap:** Check the box to send a screenshot to the SD card when motion is detected.

- **Trigger SD Recording:** Check the box to send a video recording to the SD card when motion is detected.
  - **Trigger E-mail:** Check the box to set out an e-mail notification when motion is detected. Enter the e-mail addresses to receive the notification. To send the e-mail to more than one e-mail address, separate the accounts with a comma. Check the box next to “Attach Picture” to include a screenshot of the event. Enter the e-mail subject and any notes, if needed, in the content field. The sending e-mail address must be set in the E-mail configuration interface before e-mail notifications can work.
  - **Trigger FTP:** Check the box to send a screenshot of the event to an FTP server. Enter the server’s address in the field. See the FTP configuration section for more information.
3. Click the “Save” button to save the settings.
  4. Click on the “Schedule” tab to set the motion detection schedule. Select which hours, from 0 to 24, for each day, will have SD card recording enabled. Green means scheduled. Blank means unscheduled.
    - “Add”: Add the schedule for a special day. Drag the mouse to set the time on the timeline.
    - “Erase”: Delete the schedule. Drag the mouse to erase the time on the timeline.
    - Manual Input: Click it for a specific day to enter specific start and end times. This adds more granularities (minutes).
    - Users can also add “Holiday Schedule” to be applied to special dates.  
Note: The holiday schedule takes priority over the weekly schedule.

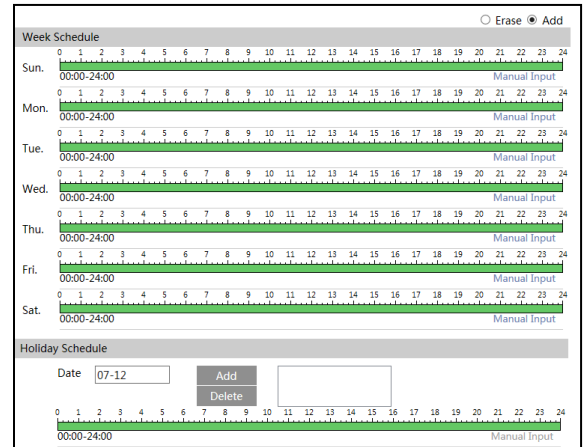

#### 4.3.4 Alarm Out

The alarm input menu is available on models with alarm input and output support (DWC-MV94Wi28T, DWC-MV94Wi36T and DWC-MV94WiAT). To set the alarm output:

**Alarm Out Mode:** Select from the drop-down options the action to activate an alarm output. Alarm linkage, manual operation, day/night switch linkage and timing are optional.

- **Alarm Linkage:** When selected, the alarm output will be triggered when the alarm input is activated. Enter the alarm out name, alarm holding time and alarm type (NO/NC).

Alarm Out Mode	Alarm Linkage
Alarm Out Name	alarmOut1
Alarm Holding Time	20 Seconds
Alarm Type	NC
Save	

- **Manual Operation:** When selected, the alarm output will be triggered manually from the camera’s GUI. Enter the alarm type (NO/NC) and click “Open” to trigger the alarm out immediately; click “Close” to stop the alarm.

Alarm Out Mode	Manual Operation
Alarm Type	NC
Manual Operation	Open Close
Save	

- **Day/Night Switch Linkage:** When selected, the alarm output will be triggered when the camera switches from color to B/W. Select the alarm type (NO/NC). Choose to open or close the alarm out when the camera switches to color (day) mode or B/W (night) mode.

Alarm Out Mode	Day/night switch linkage
Alarm Type	NC
Day	Close
Night	Close

- Timing:** When timing is selected, the alarm output will be triggered on schedule. Select the alarm type (NO/NC). Click “Add” and drag the mouse on the timeline to set the schedule of alarm out. Click “Erase” and drag the mouse on the timeline to erase the set time schedule.

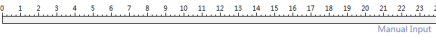
Alarm Out Mode	Timing
Alarm Type	NC
Time Range	<input type="radio"/> Erase <input checked="" type="radio"/> Add 
Save	

#### 4.3.5 Alarm Server

Alarm server settings let you set an alarm output to a dedicated server. Enter the server’s IP address and port, information, and set the heartbeat and heartbeat interval (in seconds). When an alarm occurs, the camera will transfer the alarm event to the alarm server.

Server Address	<input type="text"/>
Port	<input type="text" value="0"/>
Heartbeat	Disable
Heartbeat interval	<input type="text" value="30"/> Second



## 4.4 Event Configuration

The Event Configuration menu includes setup for video tampering, line crossing and intrusion. For improved accuracy, consider the following before installation:

- Cameras should be installed on a stable surface. Vibrations can have an impact on the detection accuracy.
- Avoid pointing the camera at reflective surfaces (such as shiny floors, mirrors, glass, lake surfaces, etc.).
- Avoid narrow places or places that have too many shadows.
- Avoid cases where the detection object's color is similar to the background color.
- At any time, avoid over- and underexposure and make sure the image of the camera is clear.

### 4.4.1 Video Tampering Detection

The camera can trigger events based on scene change, video blur and color changes.

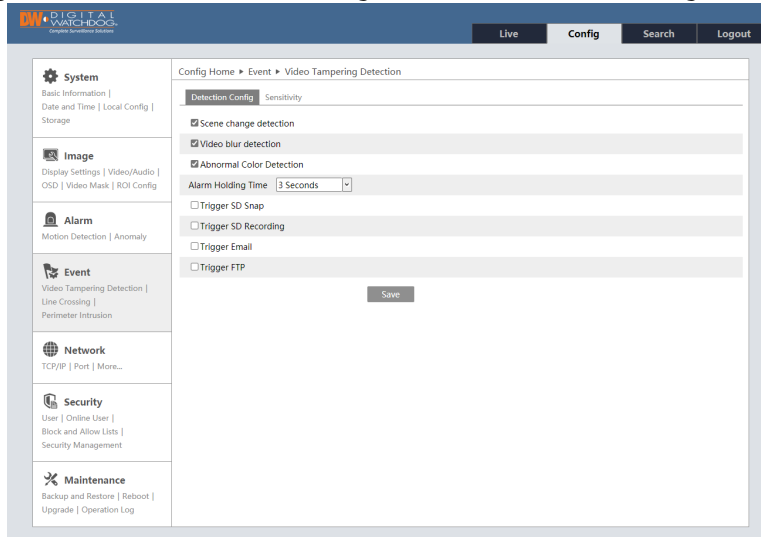

- Enable the camera tampering events by checking the box next to the ones needed.
  - **Scene change detection:** When the camera's scene changes, an alarm is triggered.
  - **Video blur detection:** When the camera's video becomes blurry, an alarm is triggered.
  - **Abnormal color detection:** When the camera's image becomes obscure, an alarm is triggered.
- **Alarm Holding Time:** Set the time between each event notification.
- **Trigger Alarm Out:** For cameras with an alarm output connection, check the box for the camera to trigger the alarm output.
- **Trigger SD Snap:** Check the box to send a screenshot to the SD card when motion is detected.
- **Trigger SD Recording:** Check the box to send a video recording to the SD card when motion is detected.
- **Trigger E-mail:** Check the box to set out an e-mail notification when motion is detected. Enter the e-mail addresses to receive the notification. To send the e-mail to more than one e-mail address, separate the accounts with a comma. Check the box next to "Attach Picture" to include a screenshot of the event. Enter the e-mail subject and any notes, if needed, in the content field. The sending e-mail address must be set in the E-mail configuration interface before e-mail notifications can work.
- **Trigger FTP:** Check the box to send a screenshot of the event to an FTP server. Enter the server's address in the field. See the FTP configuration section for more information.

To set the camera's sensitivity to these external changes, open the "Sensitivity" and adjust the sensitivity bar.

**Scene change detection:** The higher the value, the smaller changes in the scene will trigger an event

**Video blur detection:** The higher the value, the small amount of blurriness in the image will trigger an event.

**Abnormal color detection:** The higher the value, the subtle color changes in the image will trigger an event.

※ Camera and surrounding area configuration considerations:

1. Auto-focusing should not be enabled for line crossing detection.
2. Avoid scenes with excessive light changes.

## 4.4.2 Line Crossing

**Line Crossing:** An alarm is triggered if a target crosses the pre-defined alarm lines.

The screenshot shows the 'Detection Config' interface with the following settings:

- Enable:**
- Save Panoramic Picture:**
- Save Target Cutout:**
- Detection Target:**
  - Human (Sensitivity: 50)
  - Motor Vehicle (Sensitivity: 50)
  - Motorcycle/Bicycle (Sensitivity: 50)
- Alarm Holding Time:** 20 Seconds
- Trigger Alarm Out:**  Alarm Out
- Trigger Snap:**
- Trigger SD Recording:**
- Trigger Email:**
- Trigger FTP:**

A 'Save' button is located at the bottom of the interface.

1. Check the box to enable this feature.
  - Check the box to Save Panoramic Picture when the event is triggered.
  - Check the box to Save a Target Cutout picture in the SD card when the event is triggered.  
Note: To save snapshots to the local PC, please enable “Local Smart Snapshot Storage” in the local config. interface first. To save snapshots to the SD card, please install an SD card first.
  - **Detection Target:** Check the box next to the objects you want the camera to detect and set the sensitivity accordingly. Each sensitivity is set by default to 50. If no object/target is selected, alarms will not be triggered even if line crossing detection is enabled. Users can check more than one box.
    - **Human:** Select it and then alarms will be triggered if someone crosses the pre-defined alarm lines.
    - **Motor Vehicle:** Select it and then alarms will be triggered if a vehicle with four or more wheels (e.g. a car, bus, or truck) crosses the pre-defined alarm lines.
    - **Motorcycle/Bicycle:** Select it and then alarms will be triggered if a vehicle with two wheels (e.g. a motorcycle or bicycle) crosses the pre-defined alarm lines.
  - **Alarm Holding Time:** Set the time between each event notification.
  - **Trigger Alarm Out:** For cameras with an alarm output connection, check the box for the camera to trigger the alarm output.
  - **Trigger SD Snap:** Check the box to send a screenshot to the SD card when motion is detected.
  - **Trigger SD Recording:** Check the box to send a video recording to the SD card when motion is detected.
  - **Trigger E-mail:** Check the box to set out an e-mail notification when motion is detected. Enter the e-mail addresses to receive the notification. To send the e-mail to more than one e-mail address, separate the accounts with a comma. Check the box next to “Attach Picture” to include a screenshot of the event. Enter the e-mail subject and any notes, if needed, in the content field. The sending e-mail address must be set in the E-mail configuration interface before e-mail notifications can work.
  - **Trigger FTP:** Check the box to send a screenshot of the event to an FTP server. Enter the server's address in the field. See the FTP configuration section for more information.
2. Click on the “Area” tab and set the detection zone and sensitivity of the line crossing alarm. Click the “Area and Sensitivity” tab to go to the interface shown below.

The screenshot shows the 'Area and Sensitivity' interface with the following settings:

- Alarm Line:** 1
- Direction:** A->B

The interface includes a video feed of a museum gallery with a yellow line drawn across it, labeled 'A' and 'B'. Below the video feed are 'Draw Area' and 'Clear' buttons. A 'Save' button is located at the bottom right of the interface.

Select the alarm line number. The camera supports up to 4 lines. Multiple lines cannot be added simultaneously.

- **Direction:** Indicate the direction objects have to cross the detection line to trigger an event.
  - **A<->B:** Objects crossing the detection line in any direction will trigger an event.
  - **A->B:** Objects crossing the detection line from side A to side B will trigger an event.
  - **A<-B:** Objects crossing the detection line from side B to side A will trigger an event.
- Click the “Draw Area” button and drag the mouse to draw the detection line in the preview image. Click the “Stop Draw” button to stop drawing.  
Click the “Clear” button to delete the line.  
Click the “Save” button to save the settings.

3. Click on the “Schedule” tab to set the motion detection schedule. Select which hours, from 0 to 24, for each day, will have SD card recording enabled. Green means scheduled. Blank means unscheduled.

- “Add”: Add the schedule for a special day. Drag the mouse to set the time on the timeline.
- “Erase”: Delete the schedule. Drag the mouse to erase the time on the timeline.
- Manual Input: Click it for a specific day to enter specific start and end times. This adds more granularities (minutes).
- Users can also add “Holiday Schedule” to be applied to special dates.

Note: The holiday schedule takes priority over the weekly schedule.

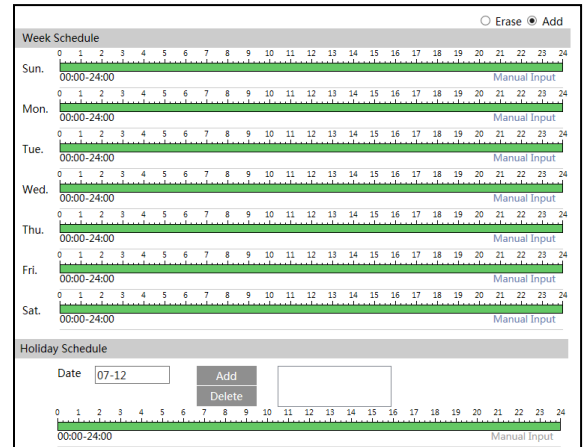

※ Camera and surrounding area configuration considerations:

3. Auto-focusing should not be enabled for line crossing detection.
4. Avoid scenes with trees or scenes with light changes (such as flashing headlights). The ambient brightness of the scenes should not be too low.
5. Cameras should be mounted at 9.18 feet (2.8 meters) or higher.
6. Keep the mounting angle of the camera at about 45°.
7. Detected objects should not be less than 1% of the entire image or more than 1/8 of the entire image.
8. Make sure cameras can view objects for at least 2 seconds in the detected area for accurate detection.
9. Adequate light and clear scenery are crucial for line crossing detection.

### 4.4.3 Perimeter Intrusion

Alarms are triggered when objects intrude into the pre-defined detection areas. This function is useful for applications such as restricted or dangerous areas such as military administrative zones, high danger areas, no man's areas, etc.

The screenshot shows a web interface for configuring detection settings. At the top, there are three tabs: 'Detection Config' (selected), 'Area', and 'Schedule'. Below the tabs, there are several sections:

- Enable:** A checked checkbox.
- Save Panoramic Picture:** An unchecked checkbox.
- Save Target Cutout:** An unchecked checkbox.
- Detection Target:** A section containing three rows, each with a checked checkbox and a sensitivity slider set to 50:
  - Human:** Sensitivity 50
  - Motor Vehicle:** Sensitivity 50
  - Motorcycle/Bicycle:** Sensitivity 50
- Alarm Holding Time:** A dropdown menu set to '20 Seconds'.
- Trigger Alarm Out:** A section with an unchecked checkbox labeled 'Alarm Out'.
- Trigger Snap:** An unchecked checkbox.
- Trigger SD Recording:** An unchecked checkbox.
- Trigger Email:** An unchecked checkbox.
- Trigger FTP:** An unchecked checkbox.

A 'Save' button is located at the bottom right of the interface.

1. Check the box to enable this feature.
  - Check the box to Save Panoramic Picture when the event is triggered.
  - Check the box to Save a Target Cutout picture in the SD card when the event is triggered.  
Note: To save snapshots to the local PC, please enable “Local Smart Snapshot Storage” in the local config. interface first. To save snapshots to the SD card, please install an SD card first.
  - **Detection Target:** Check the box next to the objects you want the camera to detect and set the sensitivity accordingly. Each sensitivity is set by default to 50. If no object/target is selected, alarms will not be triggered even if line crossing detection is enabled. Users can check more than one box.
    - **Human:** Select it and then alarms will be triggered if someone crosses the pre-defined alarm lines.
    - **Motor Vehicle:** Select it and then alarms will be triggered if a vehicle with four or more wheels (e.g. a car, bus, or truck) crosses the pre-defined alarm lines.
    - **Motorcycle/Bicycle:** Select it and then alarms will be triggered if a vehicle with two wheels (e.g. a motorcycle or bicycle) crosses the pre-defined alarm lines.
  - **Alarm Holding Time:** Set the time between each event notification.
  - **Trigger Alarm Out:** For cameras with an alarm output connection, check the box for the camera to trigger the alarm output.
  - **Trigger SD Snap:** Check the box to send a screenshot to the SD card when motion is detected.
  - **Trigger SD Recording:** Check the box to send a video recording to the SD card when motion is detected.
  - **Trigger E-mail:** Check the box to set out an e-mail notification when motion is detected. Enter the e-mail addresses to receive the notification. To send the e-mail to more than one e-mail address, separate the accounts with a comma. Check the box next to “Attach Picture” to include a screenshot of the event. Enter the e-mail subject and any notes, if needed, in the content field. The sending e-mail address must be set in the E-mail configuration interface before e-mail notifications can work.
  - **Trigger FTP:** Check the box to send a screenshot of the event to an FTP server. Enter the server’s address in the field. See the FTP configuration section for more information.

- Click on the “Area” tab and set the detection zone. Click the “Area” tab to go to the interface as shown below.

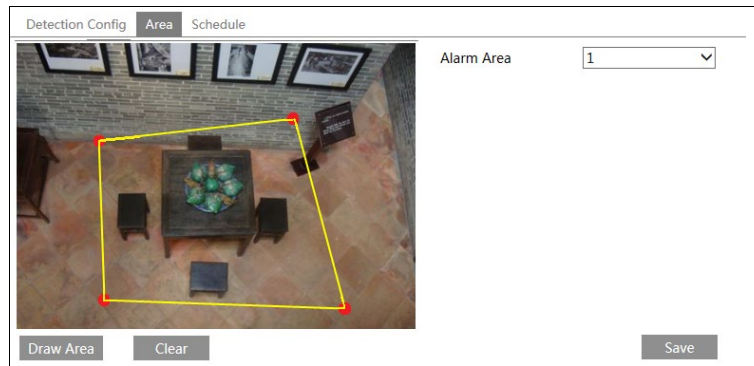

Select the alarm area number on the right side. Up to 4 alarm areas can be added.

- Time Threshold: set the time between each object intruding the detection zone before alarms are triggered.
  - Sensitivity: set the detection sensitivity. The higher the number, the smaller the objects detected can be.
  - Scale: Adjust the scale of the objects entering the detection area.
  - Click the “Draw Area” button and then click around the area where you want to set as the alarm area in the image on the left side (the alarm area should be a closed area). Click the “Stop Draw” button to stop drawing. Click the “Clear” button to delete the alarm area. Click the “Save” button to save the settings.
- Click on the “Schedule” tab to set the motion detection schedule. Select which hours, from 0 to 24, for each day, will have SD card recording enabled. Green means scheduled. Blank means unscheduled.

- “Add”: Add the schedule for a special day. Drag the mouse to set the time on the timeline.
- “Erase”: Delete the schedule. Drag the mouse to erase the time on the timeline.
- Manual Input: Click it for a specific day to enter specific start and end times. This adds more granularities (minutes).
- Users can also add “Holiday Schedule” to be applied to special dates.  
Note: The holiday schedule takes priority over the weekly schedule.

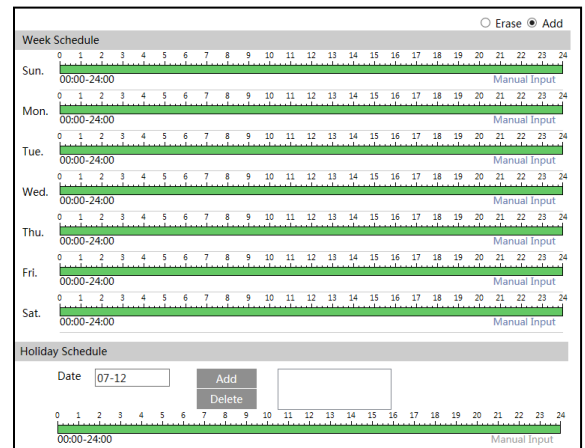

※ Camera and surrounding area configuration considerations:

- Auto-focusing should not be enabled for line crossing detection.
- Avoid scenes with trees or scenes with light changes (such as flashing headlights). The ambient brightness of the scenes should not be too low.
- Cameras should be mounted at 9.18 feet (2.8 meters) or higher.
- Keep the mounting angle of the camera at about 45°.
- Detected objects should not be less than 1% of the entire image or more than 1/8 of the entire image.
- Make sure cameras can view objects for at least 2 seconds in the detected area for accurate detection.
- Adequate light and clear scenery are crucial for line crossing detection.

## 4.5 Network Configuration

### 4.5.1 TCP/IP

Use the setup menu below to adjust the camera's TCP/IP settings.

The screenshot shows the camera's web interface for TCP/IP configuration. The sidebar on the left lists various system settings. The main panel is titled 'Config Home > Network > TCP/IP' and features four tabs: IPv4, IPv6, PPPoE Config, and IP Change Notification Config. The IPv4 tab is selected, displaying the following configuration options:

- Obtain an IP address automatically
- Use the following IP address
- IP Address: 192.168.10.26 (with a Test button)
- Subnet Mask: 255.255.255.0
- Gateway: 192.168.10.1
- Preferred DNS Server: 192.168.226.1
- Alternate DNS Server: 8.8.8.8
- Save button

Chose to use IPv4 or IPv6 tabs to setup the camera's IP settings. Contact your network administrator for more information.

- **Obtain an IP address automatically:** when selected, the camera will obtain its IP address and network settings based on the information from the router.
- **Use the following IP address:** Enter the camera's IP address manually. If this option is selected, enter the following information:
  - **IP Address:** enter the camera's IP address in the format of xxx.xxx.xxx.
  - **Test:** use this option to test the camera IP address is correct and available.
  - **Subnet Mask:** enter the network's subnet mask in the format of xxx.xxx.xxx.
  - **Gateway:** enter the router's gateway address in the format of xxx.xxx.xxx.
  - **Preferred DNS Server:** enter the DNS server for the camera.
  - **Alternate DNR Server:** if needed, enter a secondary DNR server's address.

**Use PPPoE-**Click the "PPPoE Config" tab to enable PPPoE. Enter the username and password. Contact your network administrator for more information.

The screenshot shows the camera's web interface for PPPoE configuration. The page has four tabs: IPv4, IPv6, PPPoE Config, and IP Change Notification Config. The PPPoE Config tab is selected, displaying the following configuration options:

- Enable
- User Name: xxxxxxx
- Password: [masked]
- Save button

If PPPoE is used to connect to the internet, the camera will get a dynamic WAN IP address. This IP address will change frequently.

## IP Change Notification Config.

Enable this option to be notified when the camera's IP address is changing.

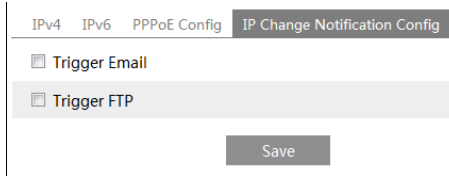

The screenshot shows the 'IP Change Notification Config' page. At the top, there are tabs for 'IPv4', 'IPv6', 'PPPoE Config', and 'IP Change Notification Config'. Below the tabs, there are two checkboxes: 'Trigger Email' and 'Trigger FTP', both of which are currently unchecked. At the bottom of the form, there is a 'Save' button.

**Trigger E-mail:** when the IP address changes, the new IP address will be sent to the e-mail address entered here.

**Trigger FTP:** when the IP address changes, the new IP address will be sent to the FTP server entered here.

## 4.5.2 Port

HTTP port, Data port and RTSP port can be set.

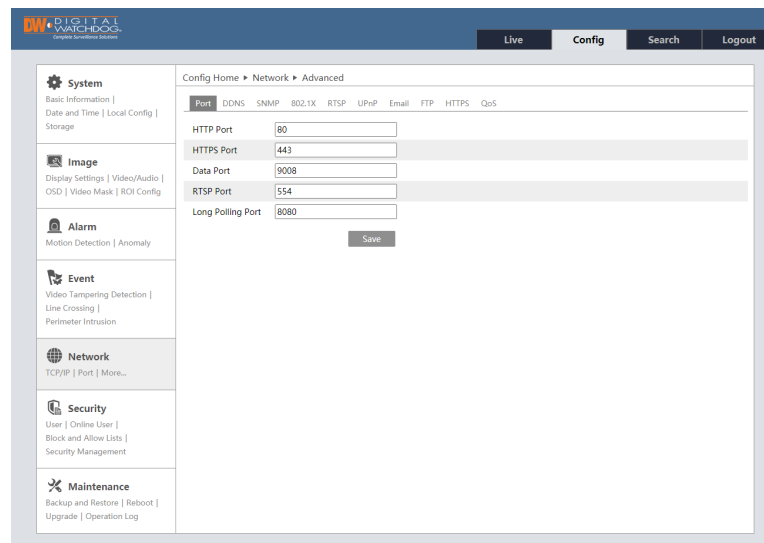

The screenshot shows the 'Port' configuration page in the 'Advanced' network settings. The page has a sidebar with categories: System, Image, Alarm, Event, Network, Security, and Maintenance. The main content area is titled 'Port' and contains the following fields: 'HTTP Port' (80), 'HTTPS Port' (443), 'Data Port' (9008), 'RTSP Port' (554), and 'Long Polling Port' (8080). A 'Save' button is located at the bottom right of the form.

- **HTTP Port:** The default HTTP port is 80 and can be changed to any port that is not occupied.
- **HTTPS Port:** The default HTTPS port is 443 and can be changed to any port that is not occupied.
- **Data Port:** The default data port is 9008 and can be changed to any port that is not occupied.
- **RTSP Port:** The default port is 554 and can be changed to any port that is not occupied.

## 4.5.3 DDNS

If the camera is set up with a DHCP connection, a DDNS is recommended to connect to the camera over the internet.

Enable the DDNS function and select one of the server types from the drop-down menu. Please note that some of these will require registration at the DDNS server side. Contact your network administrator for more information.

Once you obtain a DDNS username, password and domain name, enter all the information in the fields below and click "Save" to save all settings.

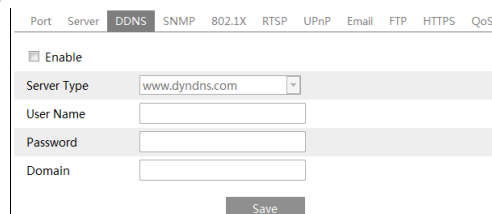

The screenshot shows the 'DDNS' configuration page. At the top, there are tabs for 'Port', 'Server', 'DDNS', 'SNMP', '802.1X', 'RTSP', 'UPnP', 'Email', 'FTP', 'HTTPS', and 'QoS'. Below the tabs, there is an 'Enable' checkbox which is checked. Below that is a 'Server Type' dropdown menu with 'www.dyndns.com' selected. There are four text input fields: 'User Name', 'Password', and 'Domain'. At the bottom, there is a 'Save' button.

#### 4.5.4 SNMP

Use the SNMP settings page to get the camera status, parameters and alarm information. Before using SNMP, Contact your network administrator for more information.

SNMP v1/v2	
<input type="checkbox"/> Enable SNMPv1	
<input type="checkbox"/> Enable SNMPv2	
Read SNMP Community	<input type="text"/>
Write SNMP Community	<input type="text"/>
Trap Address	<input type="text"/>
Trap Port	<input type="text" value="0"/>
Trap community	<input type="text"/>
SNMP v3	
<input type="checkbox"/> Enable SNMPv3	
Read User Name	<input type="text"/>
Security Level	<input type="text" value="auth, priv"/>
Authentication Algorithm	<input type="radio"/> MD5 <input type="radio"/> SHA
Authentication Password	<input type="text"/>
Private-key Algorithm	<input type="radio"/> DES <input type="radio"/> AES
Private-key Algorithm	<input type="text"/>
Write User Name	<input type="text"/>
Security Level	<input type="text" value="auth, priv"/>
Authentication Algorithm	<input type="radio"/> MD5 <input type="radio"/> SHA
Authentication Password	<input type="text"/>
Private-key Algorithm	<input type="radio"/> DES <input type="radio"/> AES
Private-key Algorithm	<input type="text"/>
Other Settings	
SNMP Port	<input type="text" value="0"/>

Select which SNMP version to use (SNMPv1, SNMPv2, SNMPv3), and fill out the information under each section accordingly.

#### 4.5.5 802.1x

If enabled, when the camera is connected to the network, the data streamed from the camera will be protected by the IEEE802.1x. User authentication is needed.

<input checked="" type="checkbox"/> Enable	
Protocol Type	<input type="text" value="EAP_MD5"/>
EAPOL Version	<input type="text" value="1"/>
User Name	<input type="text" value="test"/>
Password	<input type="password" value="•••••"/>
Confirm Password	<input type="password" value="•••••"/>

The camera must be connected to a switch supporting 802.1x protocol.

Protocol type and EAPOL version: Please use the default settings.

Username and password: The username and password must be the same with the username and password applied for and registered in the authentication server.



## 4.5.6 RTSP

Use this setup screen to configure the camera's RTSP settings.

The screenshot shows the 'RTSP' configuration page in the Digital Watchdog web interface. The page is titled 'Config Home > Network > Advanced'. On the left, there is a navigation menu with sections: System, Image, Alarm, Event, Network, Security, and Maintenance. The main content area is for RTSP configuration. It includes a 'Port' field set to 554, an 'Address' field with a placeholder 'rtsp://IP or domain name:port/profile1', and three 'Multicast address' rows. The first row is 'Main stream' with IP 239.0.0.0 and port 50554. The second is 'Sub stream' with IP 239.0.0.1 and port 51554. The third is 'Third stream' with IP 239.0.0.2 and port 52554. There is also an 'Audio' row with IP 239.0.0.3 and port 53554. Each multicast row has an 'Automatic start' checkbox. At the bottom, there is a checkbox for 'Allow anonymous login (No username or password required)' and a 'Save' button.

Select "Enable" to enable the RTSP function.

- **Port:** Access port of the streaming media. The default is 554.
- **RTSP Address:** The RTSP address (unicast) format can be used to play the stream in a media player.
- **Multicast Address**
  - **Mainstream:** The address format is: "rtsp://IP address: rtsp port/profile1?transportmode=mcast".
  - **Substream:** The address format is: "rtsp://IP address: rtsp port/profile2?transportmode=mcast".
  - **Third stream:** The address format is: "rtsp://IP address: rtsp port/profile3?transportmode=mcast".
  - **Audio:** Having entered the main/substream in a VLC player, the video and audio will play automatically.

If "Allow anonymous login (no username or password required)" is checked, there is no need to enter the username and password to view the video.

### Notes:

1. The camera supports local play through a VLC player. Enter the RTSP address (unicast or multicast, eg. RTSP://192.168.226.201:554/profile1?transportmode=mcast) in a VLC player to realize the simultaneous play with the web client.
2. The IP address mentioned above cannot be the address of IPv6.
3. Avoid the use of the same multicast address in the same local network.
4. When playing the video through the multicast streams in a VLC player, please pay attention to the mode of the VLC player. If it is set to TCP mode, the video cannot be played.
5. If the coding format of the video of the mainstream is MJPEG, the video may be disordered at some resolutions.

#### 4.5.7 UPnP

When UPnP is enabled, the camera can be quickly accessed through the LAN. Enable UPnP and then enter the UPnP name.



#### 4.5.8 E-mail

For all e-mail notifications for events and camera status, an e-mail address must be set as the sender e-mail.

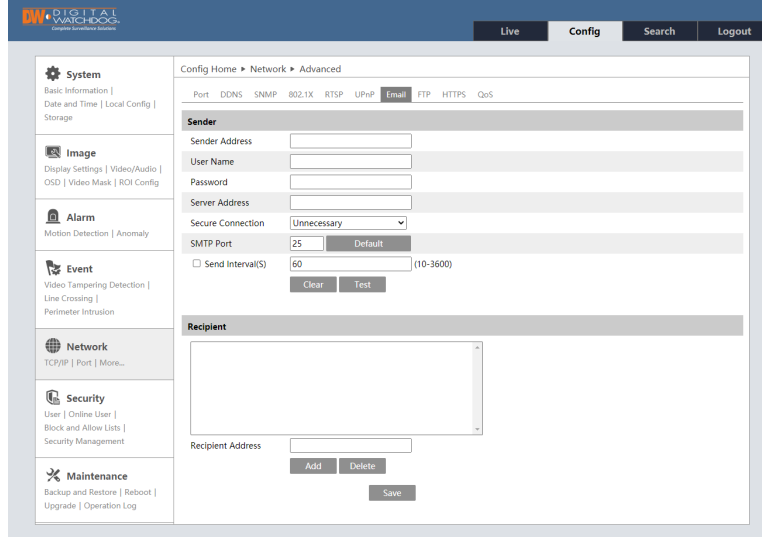

- **Sender Address:** enter the sender's e-mail address.
- **Username and password:** enter the sender's username and password. In most cases, the sender's username should be the same as the sender's e-mail address.
- **Server Address:** The SMTP IP address or hostname.
- **Secure Connection:** Select the secure connection type from the drop-down options.
- **SMTP Port:** Enter the SMTP port for the sending e-mail account.
- **Send Interval(s):** The time interval of sending each e-mail notification, set in seconds. For example, if the interval is set to 60 seconds and multiple similar alarms are triggered (all motion detection, for example) within 60 seconds, all alarms within that time frame will be considered as a single alarm event and generate a single e-mail. If one motion alarm event is triggered and then another motion detection alarm event is triggered after 60 seconds, two e-mails will be sent. When different alarms are triggered at the same time, multiple e-mails will be sent separately.
- Click the "Test" button to check the account credentials.
- **Recipient Address:** Enter the receiver's e-mail address. Multiple e-mail addresses can be separated by commas.

#### 4.5.9 FTP

Once an FTP server is configured on this page, captured images from events can be uploaded to the FTP server.

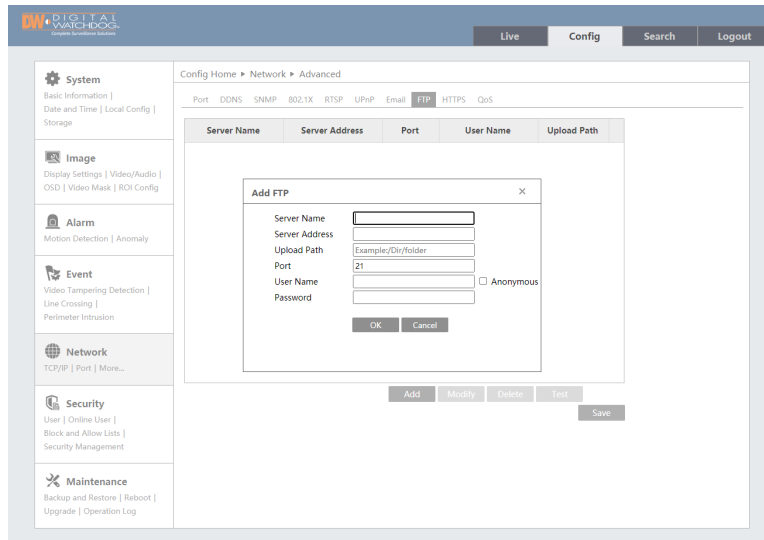

- **Server Name:** Enter the name of the FTP server.
- **Server Address:** Enter the IP address or domain name of the server.
- **Upload Path:** Indicate the directory where files will be uploaded.
- **Port:** Enter the port of the server.
- **Username and Password:** Enter the username and password to login into the server.

#### 4.5.10 HTTPS

HTTPS provides authentication of the web site and protects the user's privacy.

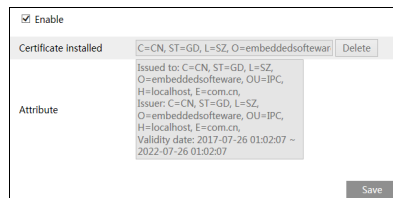

Once enabled, the camera can be accessed by entering <https://IP:port> (e.g. https://192.168.226.201:443).

A private certificate can be created. Click "Delete" and select one of the three options below:

- Select "Have signed certificate, install directly" if a signed certificate is available. Click "Browse" to select it and then click "Install" to install it.
- Select "Create a private certificate" and click the "Create" button to create a private certificate. Enter the required information and click "OK" to save the settings.
- Select "Create a certificate request" to create the certificate request. Download the certificate request and submit it to a trusted certificate authority for signature. Once the certificate is signed, import the certificate back to the device.

#### 4.5.11 QoS

QoS (Quality of Service) provides different quality services for different network applications. If bandwidth is limited, the router or switch can sort the data streams and transfer them according to their priority.

Users can assign a DSCP (Differentiated Services Code Point) value between 0 and 63 for each stream from the camera. DSCP is used to request high priority or best-effort delivery for traffic. The higher the value, the higher the priority for that stream will be.

Video/Audio DSCP	<input type="text" value="13"/>
Alarm DSCP	<input type="text" value="35"/>
Manager DSCP	<input type="text" value="53"/>

## 4.6 Security Configuration

### 4.6.1 User Configuration

This page allows admin users to manage all users with access to the camera.

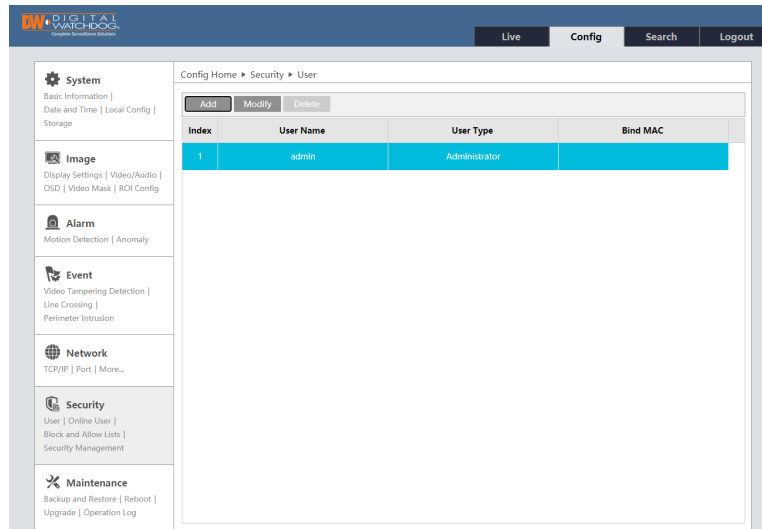

To add a user:

1. Click the “Add” button to pop up the following textbox.

arimin Administrator

Add User

User Name

Password

Level

The password can be composed of numbers, special characters, upper or lower case letters.

Confirm Password

User Type Administrator

Bind MAC 00:00:00:00:00:00

OK Cancel

2. Enter the username in the “User Name” textbox.
3. Enter the password in the “Password” and “Confirm Password”. Passwords must be set according to the password security level (Go to Config>Security>Security Management>Password Security interface to set the security level). Set a password including numbers, special characters and upper or lowercase letters.
4. Select the user type.
  - **The administrator** has all permissions and access to the camera.
  - **Normal** users can only view the live video.
  - **Advanced** user has the same permissions as an Administrator, except for user, backup settings, factory reset and upgrading the firmware.
5. To link a user to a specific PC only, enter the MAC address of the PC in the “Bind MAC” textbox.
6. Click the “OK” button to save the new user.

To modify a user, select it from the table and press the “Modify” button. Administrator users can modify the password and PC MAC address for each user.

**Note:** To change the access level of a user, or the username, the user must be deleted and added again with the new information.

To delete a user, select it from the table and click the “Delete” button. The default admin user cannot be deleted.

## 4.6.2 Online User

The “Online User settings page shows a log of all IP addresses connected to the camera, including the username being used. If needed, users (including Administrators) can be disconnected from the camera by an admin account by pressing the “Kick-off” button next to the applicable entry.

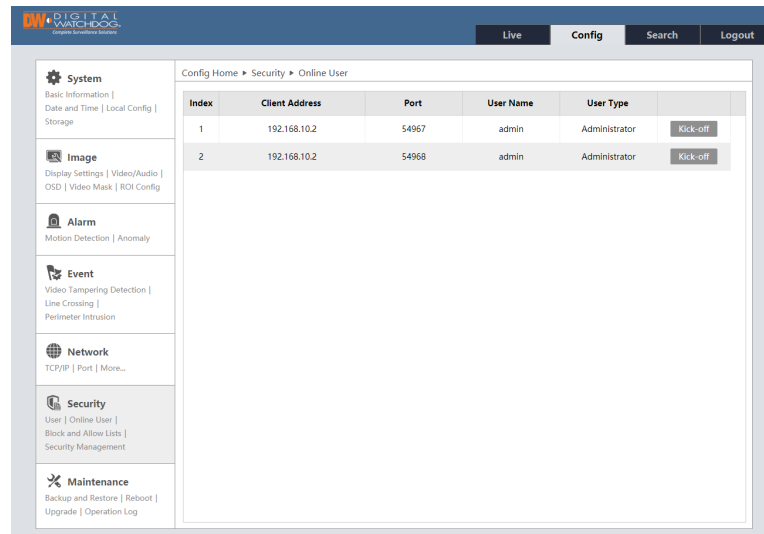

Index	Client Address	Port	User Name	User Type	
1	192.168.10.2	54967	admin	Administrator	Kick-off
2	192.168.10.2	54968	admin	Administrator	Kick-off

## 4.6.3 Block and Allow Lists

Users can list IP addresses allowed or not permitted to access the camera.

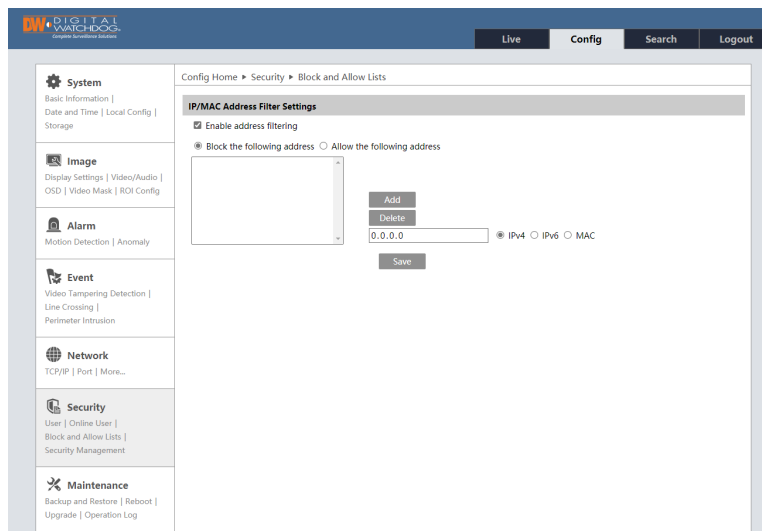

To setup IP filtering, check the box next to “Enable address filtering” and enter the information in the box below. Choose whether to allow or block an address by clicking on the appropriate option above the list window. Users can add an IPv4, IPv6 or a MAC address to the allowed and blocked lists. Once users add the address, press the “Add” button to add it to the list.

#### 4.6.4 Security Management

Security management settings allow users to setup additional security parameters for passwords and accessing the camera.

Enable “locking once illegal login” function: To prevent malicious password unlocking, the “locking once illegal login” function locks the login interface to the camera after six (6) failed login attempts. The camera can be accessed again after 30 minutes or after a camera reboot.

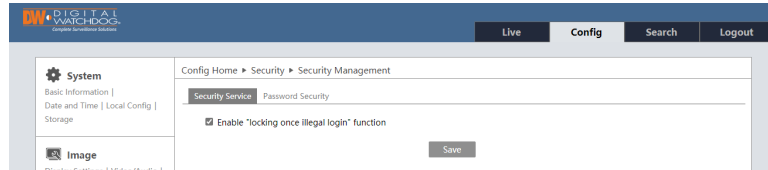

Password Security allows users to set the security level for user passwords and set an expiration date, forcing users to change their password frequently.

- Password Level: select the appropriate option from the drop-down menu.
  - Weak: There is no minimum length required. Numbers, special characters, upper or lowercase letters can be used. You can choose one of them or any combination of them when setting the password.
  - Medium: Passwords must be 9-15 characters long, including at least two of the following: numbers, special characters, upper case letters and lowercase letters.
  - Strong: Password must be 9-15 characters long, including at least one of each of the following: Numbers, special characters, upper case letters and lowercase letters.
- Expiration Time: Set a time limit for passwords. When the time limit is met, users will be prompted to change their passwords. Select from 30 days, 60 days, half a year, one year, or never.

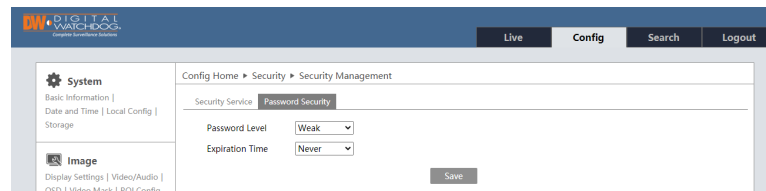

## 4.7 Maintenance Configuration

### 4.7.1 Backup and Restore

Backup & Restore allows users to import or export settings and restore the camera to its default settings.

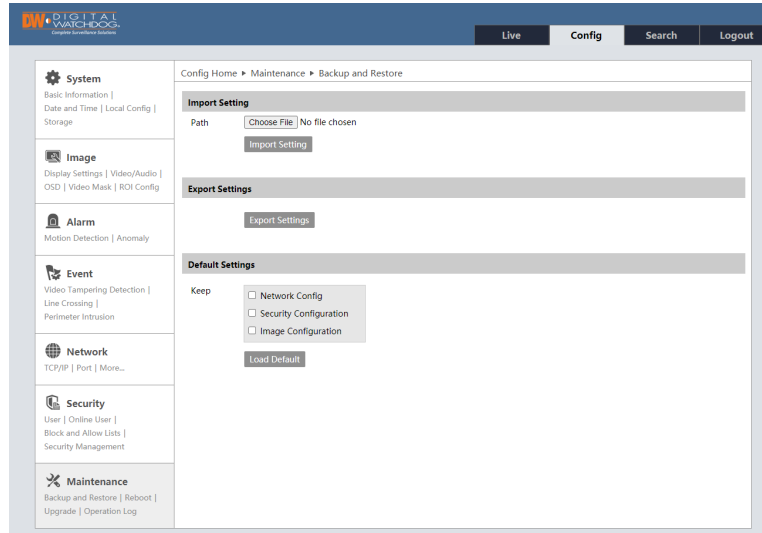

- Import & Export Settings: Import settings from a different camera, or export the current camera settings.
- Default Settings: Restore the camera to its default settings. Check the box next to the settings that will NOT be restored to default, or leave empty for a complete factory reset.

### 4.7.2 Reboot

Clicking the “Reboot” button will power cycle the camera. Please note the complete reboot process may take up to five (5) minutes to complete.

Users can also setup a reboot schedule by enabling the “Timed Reboot” settings. If enabled, select the frequency and time of day the camera will reboot automatically. Click “Save” to save all changes.

### 4.7.3 Upgrade

Use this page to upload new firmware and keep the camera up to date.

Click the “Browse” button to locate the firmware file on your PC and press the “Upgrade” button to start. Once the upgrade is completed, the camera will reboot.

The screenshot shows a 'Local upgrade' form with a 'Path' input field, a 'Browse' button, and an 'Upgrade' button.

**Caution!** Do not close the browser or disconnect the camera from the network during the upgrade.

### 4.7.4 Operation Log

View and export the camera’s operation log. Use the filters to view the report by type and start and end time. Press “Search” to apply the filters and “Export” to export the report as a .txt file for your records.

Index	Time	Main Type	Sub Type	User Name	Login IP
1	2015-07-14 11:15:18	Operation	Log in	admin	192.168.12.53
2	2015-07-14 11:12:02	Exception	Disconnected		192.168.12.53
3	2015-07-14 19:12:17	Exception	Disconnected		192.168.12.52

# 5 Search

## 5.1 Image Search

Go to the “Search” tab on the top right and select “Picture” from the first drop-down menu to search images saved locally and on the SD card.

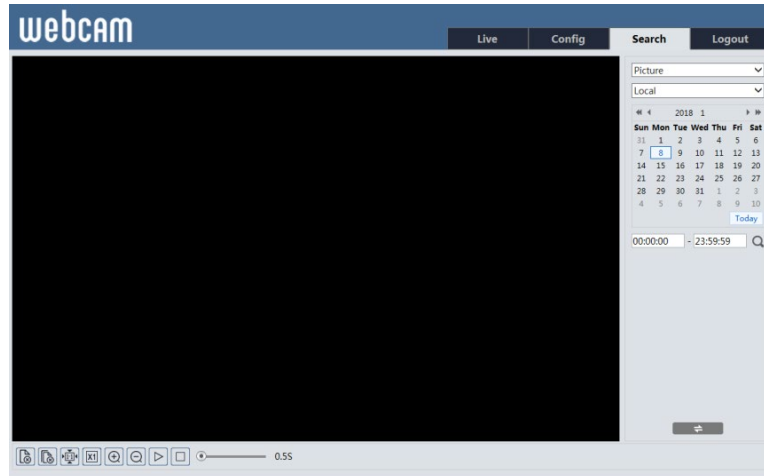

Icon	Description	Icon	Description	Icon	Description
	Close the image view.		Close all image views		Start a slide show of the selected images.
	Save the image locally on the PC.		Save all the images locally on the PC.		Stop the slide show.
	Fit the image on the screen.		Display the image in its actual size.		Digitally zoom out of the image.
	Digitally zoom into the image.				Adjust the slide show's play speed

### 5.1.1 Local Image Search

1. Choose “Picture”>“Local”.
2. Set time: Select the date and choose the start and end time.
3. Click to search the images.
4. Double-click on the file name in the results list to view the photo.

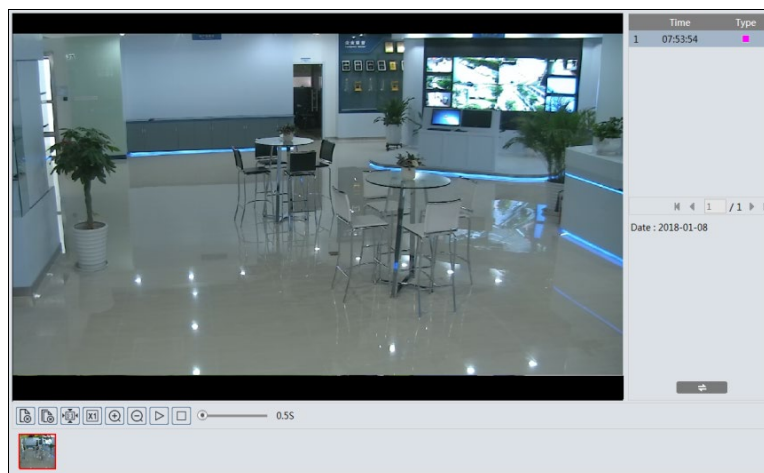



5. Click to return to the previous interface.

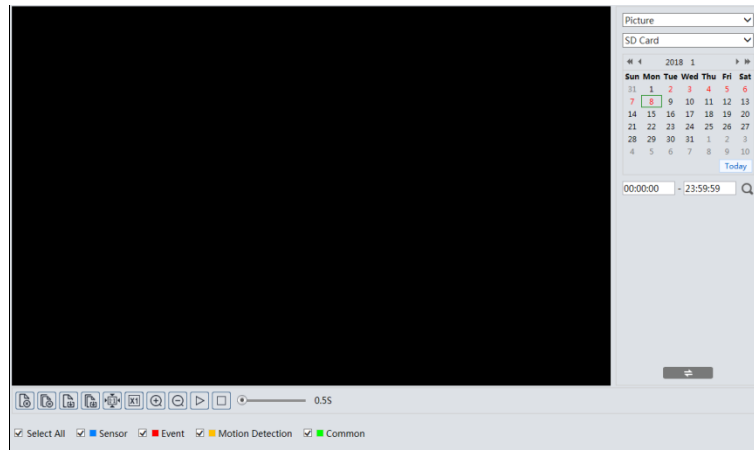

## 5.1.2 SD Card Image Search

1. Choose "Picture">"SD Card".









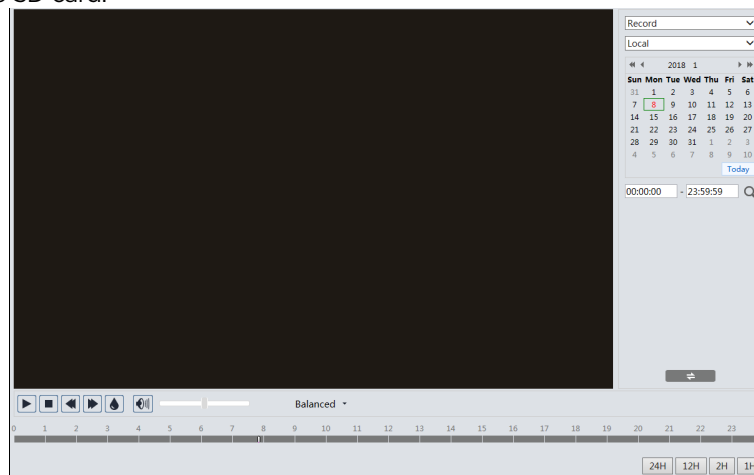

2. Set time: Select the date and choose the start and end time.
3. Choose the alarm events at the bottom of the interface.
4. Click  to search the images.
5. Double-click on a file name in the results list to view the photo.
6. Click  to return to the previous interface.



## 5.2 Video Search

Go to the "Search" tab on the top right and select "Record" from the first drop-down menu to search videos saved locally and on the SD card.



Icon	Description	Icon	Description
	Play button. After pausing the video, click this button to continue playing.		Pause button
	Stop button		Speed down
	Speed up		Watermark display
		Enable/disable audio; drag the slider to adjust the volume after enabling audio.	

## 5.2.1 Local Video Search

1. Choose “Record”>“Local”.
2. Set search time: Select the date and choose the start and end time.
3. Click  to search the videos.
4. Double-click on a file name in the results list to start playback.
5. Click  to return to the previous interface.



## 5.2.2 SD Card Video Search

1. Choose “Record”>“SD Card”.
2. Set search time: Select the date and choose the start and end time.
3. Click  to search the videos.

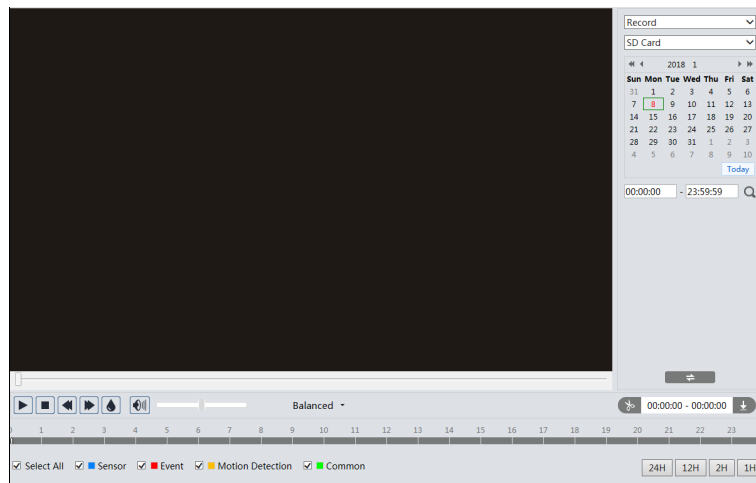

4. Select the alarm events at the bottom of the window.
5. Select a mixed stream (video and audio stream) or video stream from the drop-down above the search results to filter the results as needed.
6. Double-click on the file name in the results list to start playback.
7. Click  to return to the previous interface.

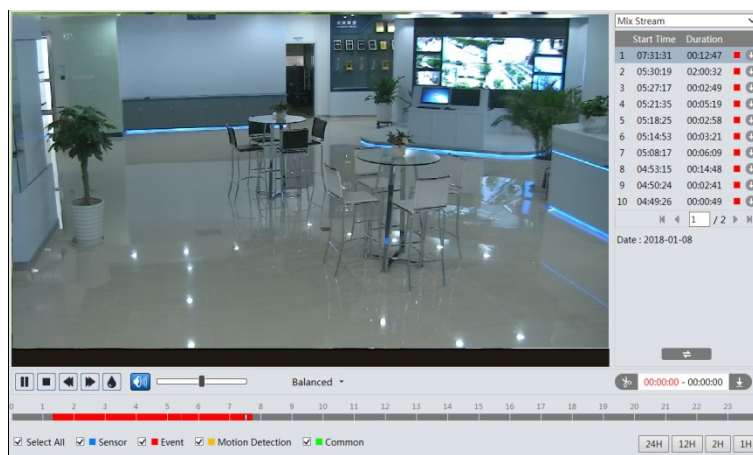

The timeline can be shown in 24H/12H/2H/1H format by clicking the corresponding buttons.

### 5.2.3 Video clip and downloading

1. To download a searched video from the search result, use the button to adjust the start time. When in use, the button will appear blue (). The start time will show in red text.
2. Select the end time by clicking on the timeline. Click the button to set the end time. The end time will show in black text.
3. Click the download button to save the cropped video locally on the PC. The pop-up window below will appear:

Index	Process	Record	Start Time	End Time	Path	Operate
1	100%	Cut	2018-01-16 01:1...	2018-01-16 01:1...	Favorites	Open

Set up D:\Favorites Clear List Close

The process column will show the download process until the download is complete.

Click "Set up" to select the directory path where the video will download.

Click "Open" to play the video after downloading is complete.

Click "Clear List" to clear the download queue list.

Click "Close" to close the download management pop-up window.

## 6 Appendix

### 6.1 Troubleshooting

What are the camera's default username, password and IP address?

A: The camera's default IP address, username and password are shown below. If you do not remember your password, please contact DW's technical support. Learn more here: <https://digital-watchdog.com/PasswordResetRequest/>

Default IP: 192.168.226.201; Username: admin; Password: admin.

Fail to connect to the camera through Internet Explorer.

A: Check that the camera is properly connected to the network and all cables are functioning properly.

B: The IP address assigned to the camera is not available or conflicting with another device on the network. Reset the camera's network settings and assign it a new IP address that is not being used.

C: The web port the camera uses changed: contact your network administrator to get the correct port number.

D: Reset the camera to default settings.

IE cannot download ActiveX control.

A. IE browser may be set up to block ActiveX. Follow the steps below.

1. Open the IE browser and then click Tools-----Internet Options.

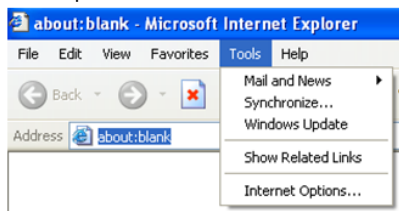

2. Select Security-----Custom Level....

3. Enable all the options under "ActiveX controls and plug-ins".

4. Click OK to finish the setup.

B. Other plug-ins or anti-virus blocks ActiveX. Uninstall or close any software or plug-in that may block ActiveX files.

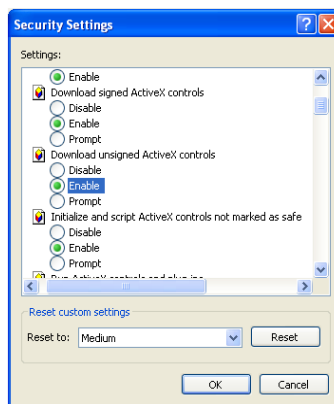
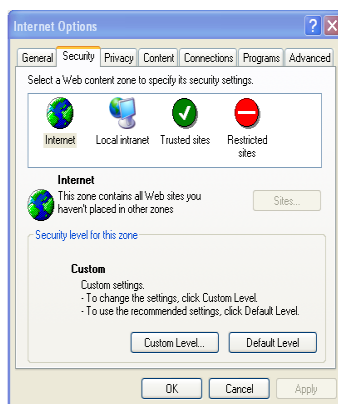

I cannot hear the camera's sound.

A: Make sure your camera supports audio input. Some models may include a microphone built-in. Others may require an external audio input device to be connected. Make sure all devices are connected properly to the camera and any necessary power supply. Connect and try again.

B: Audio function must be enabled in the camera's settings. Go to Config. > Image > Video/Audio and open the Audio tab to make sure all settings are enabled as needed.

---

## 6.2 Dimensions

DWC-MT94WiAT

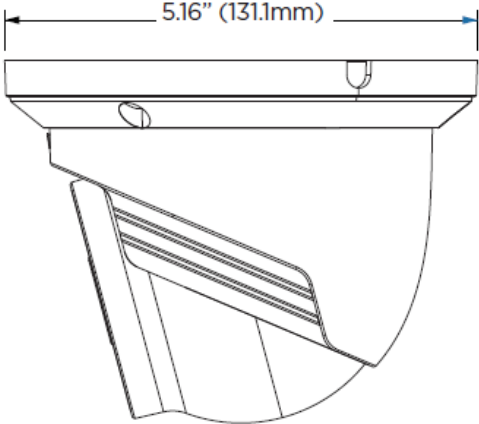
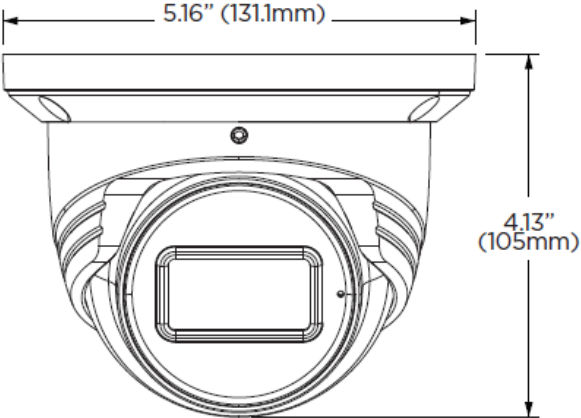

### 6.3 Specifications

	DWC-MB94Wi28T	DWC-MB94Wi36T	DWC-MT94Wi28T	DWC-MT94Wi36T	DWC-MT94WiAT	DWC-MV94Wi28T	DWC-MV94Wi36T	DWC-MV94WiAT
<b>IMAGE</b>								
Image sensor	4MP 1/3" CMOS							
Total pixels	2592(H) X 1520(V)							
Minimum scene illumination	0.005 lux (color)	0.005 lux (color)	0.005 lux (color)	0.005 lux (color)	0.0038 lux (color)	0.005 lux (color)	0.005 lux (color)	0.0038 lux (color)
	0.0 lux (B/W)							
S/N ratio	≥50dB							
<b>LENS</b>								
Focal length	2.8mm, F1.6	3.6mm, F1.6	2.8mm, F1.6	3.6mm, F1.6	2.8-12mm, F1.4	2.8mm, F1.6	3.6mm, F1.6	2.8-12mm, F1.4
Lens type	Fixed lens	Fixed lens	Fixed lens	Fixed lens	Vari-focal lens with motorized-zoom and auto-focus	Fixed lens	Fixed lens	Vari-focal lens with motorized-zoom and auto-focus
Field of view (FoV)	100.4°	80.6°	100.4°	80.6°	94.2°-29.8°	100.4°	80.6°	94.2°-29.8°
IR distance	164ft range	164ft range	100ft range	100ft range	164ft range	100ft range	100ft range	164ft range
<b>I/O</b>								
Audio in / out	1/0	1/0	1 microphone built-in/1	1 microphone built-in/1	1 microphone built-in/1	1 microphone built-in/1	1 microphone built-in/1	1 microphone built-in/1
Audio compression	G.711A / U	G.711A / U	G.711A / U	G.711A / U	G.711A / U	G.711A / U	G.711A / U	G.711A / U
Alarm in / out	N/A	N/A	N/A	N/A	N/A	1/1	1/1	1/1
<b>OPERATIONAL</b>								
Shutter mode	Auto, manual							
Shutter speed	1/30s - 1/100000s							
AGC	Auto							
Day / night	Auto, day (color), night (B/W), schedule							
Digital noise reduction	3D DNR							
WDR	True WDR low, middle, high, 120dB							
Privacy zone	4 programmable privacy masks							
Camera analytics	Line crossing, perimeter intrusion, video tampering detection (scene change, video blur, abnormal color detection), object classification (differentiate humans from objects)							
Notifications	Notifications via e-mail or FTP server							
Memory slot	Micro SD / SDHC / SDXC (card not Included)							
<b>NETWORK</b>								
LAN	802.3 compliance 10/100 LAN							
Video compression type	H.265, H.264, MJPEG							
Resolution	4MP (2592x1520) at 30fps							
Frame rate	Up to 30fps at all resolutions							
Video bitrate	64 Kbps - 8 Mbps							
Bitrate control	Multi-streaming CBR/VBR at H.264/ H.265 (controllable frame rate and bandwidth)							
Streaming capability	Dual-stream at different rates and resolutions							
IP	IPv4, IPv6							
Protocol	UDP, DHCP, NTP, RTSP, PPPoE, DDNS, SMTP, FTP, SNMP, HTTP, 802.1x, UPnP, HTTPs, QoS							
Security	IP filtering, MAC filtering, authentication (ID/PW), SSL/TSL							
ONVIF	Yes							
Web viewer	OS: Windows® Browser: Internet Explorer							

	DWC-MB94Wi28T	DWC-MB94Wi36T	DWC-MT94Wi28T	DWC-MT94Wi36T	DWC-MT94WiAT	DWC-MV94Wi28T	DWC-MV94Wi36T	DWC-MV94WiAT	
Video management software	DW Spectrum® IPVMS								
<b>ENVIRONMENTAL</b>									
Operating temperature	-22°F - 140°F (-30°C - 60°C)								
Operating humidity	10-95% RH (non-condensing)								
IP rating	IP67-rated								
IK rating	IK10 impact-resistant								
Other certifications	CE, FCC, RoHS								
<b>ELECTRICAL</b>									
Power requirement	DC 12V, PoE IEEE 802.3af Class 3. (Adapter not included)								
Power consumption	<9.5W	<9.5W	<7.5W	<7.5W	<9.5W	<7W	<7W	<8W	
<b>MECHANICAL</b>									
Material	Metal bullet housing		Metal turret housing			Metal vandal housing, polycarbonate dome			
Dimensions	8.69" x 3.16" x 2.77" (220.8 x 80.5 x 70.6 mm)		4.66" x 3.58" (118.6 x 91 mm)		5.16" x 4.13" (131.1 x 105 mm)	4.59" x 3.54" (116.6 x 90 mm)		5.43" x 3.93" (138 x 100 mm)	
Weight	1.52 lb. (0.69 kg)	1.52 lb. (0.69 kg)	1.01 lb. (0.46 kg)	1.01 lb. (0.46 kg)	1.47 lb. (0.67 kg)	1.43 lb. (0.65 kg)	1.43 lb. (0.65 kg)	1.96 lb. (0.89 kg)	
Warranty	5 year warranty								

\* Specifications are subject to change without notice.

---

## 7 Warranty Information

Digital Watchdog (referred to as “the Warrantor”) warrants the Camera against defects in materials or workmanship as follows:

**Labor:** For the initial five (5) years from the date of the original purchase if the product is determined to be defective, the Warrantor will repair or replace the unit with the new or refurbished product at its option, at no charge.

**Parts:** Also, the Warrantor will supply replacement parts for the initial two (2) years.

To obtain warranty or out of warranty service, please contact a technical support representative at: 1+ (866) 446-3595, Monday through Friday from 9:00 AM to 8:00 PM EST.

A purchase receipt or other proof of the date of the original purchase is required before warranty service is rendered. This warranty only covers failures due to defects in materials and workmanship which arise during normal use. This warranty does not cover damages which occurs in shipment or failures which are caused by products not supplied by the Warrantor or failures which result from accident, misuse, abuse, neglect, mishandling, misapplication, alteration, modification, faulty installation, setup adjustments, improper antenna, inadequate signal pickup, maladjustments of consumer controls, improper operation, power line surge, improper voltage supply, lightning damage, rental use of the product or service by anyone other than an authorized repair facility or damage that is attributable to acts of God.



---

## 8 Limits and Exclusions

There are no express warranties except as listed above. The Warrantor will not be liable for incidental or consequential damages (including without limitation, damage to recording media) resulting from the use of these products, or arising out of any breach of the warranty. All express and implied warranties, including the warranties of merchantability and fitness for a particular purpose, are limited to the applicable warranty period set forth above.

Some states do not allow the exclusion or limitation of incidental or consequential damages or limitations on how long an implied warranty lasts, so the above exclusions or limitations may not apply to you. This warranty gives you specific legal rights, and you may also have other rights from vary from state to state. If the problem is not handled to your satisfaction, then write to the following address:

Digital Watchdog, Inc.  
ATTN: RMA Department  
16220 Bloomfield Ave  
Cerritos, CA 90703

Service calls that do not involve defective materials or workmanship as determined by the Warrantor, in its sole discretion, are not covered. The cost of such service calls is the responsibility of the purchaser.